

DOCSIS 3.1 – Technischer Überblick

DOCSIS = Data over Cable Service Interface Specification

Vortrag anlässlich der Cable Days 2017, Salzburg, November 2017

Walter Fischer
Rohde&Schwarz Trainingszentrum München

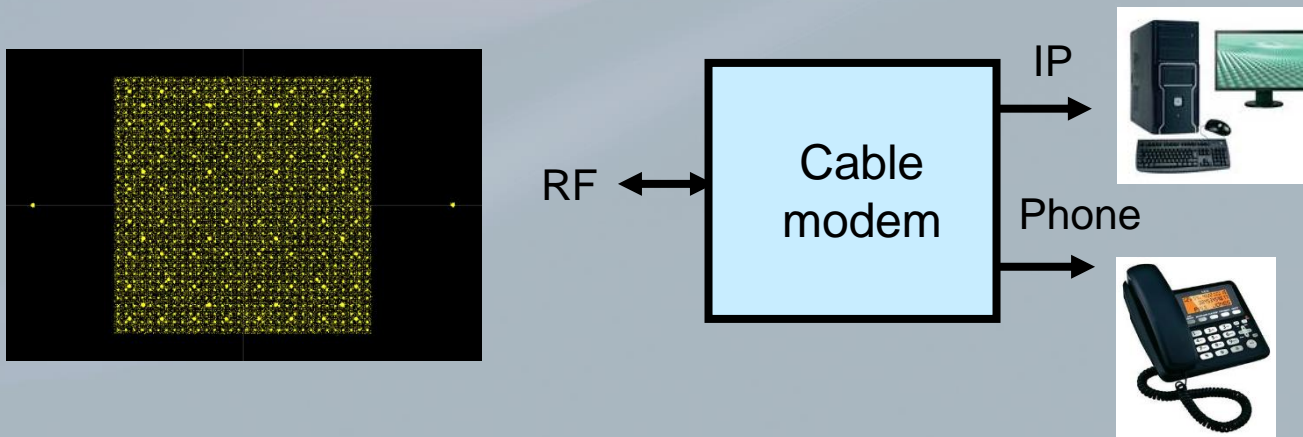

Dipl. Ing. (FH) Walter Fischer
Rohde&Schwarz
Walter.Fischer@rohde-schwarz.com



Agenda

DOCSIS Intro and Principle

Single Carrier Modulation Principle

Time Domain and Spectrum Domain

QAM and SNR Requirement

OFDM in CATV

DOCSIS 3.1 Physical Layer Parameters

DOCSIS 3.1 Demo Transmission



DOCSIS Intro and Principle

DOCSIS Intro and Principle

Single Carrier Modulation Principle

Time Domain and Spectrum Domain

QAM and SNR Requirement

OFDM in CATV

DOCSIS 3.1 Physical Layer Parameters

DOCSIS 3.1 Demo Transmission



Broadband Internet & Telephone via CATV

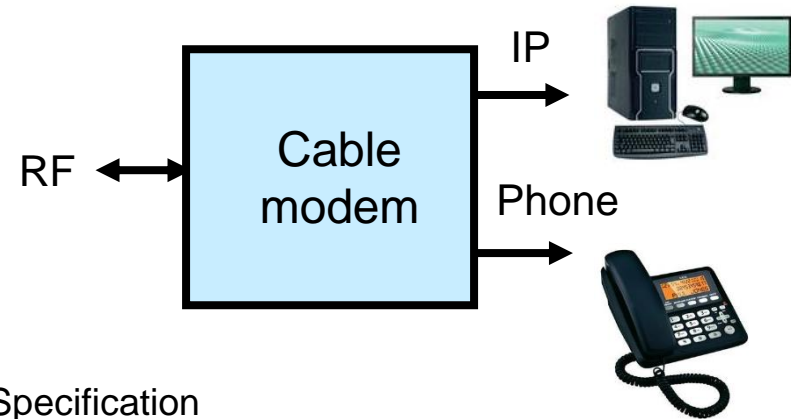
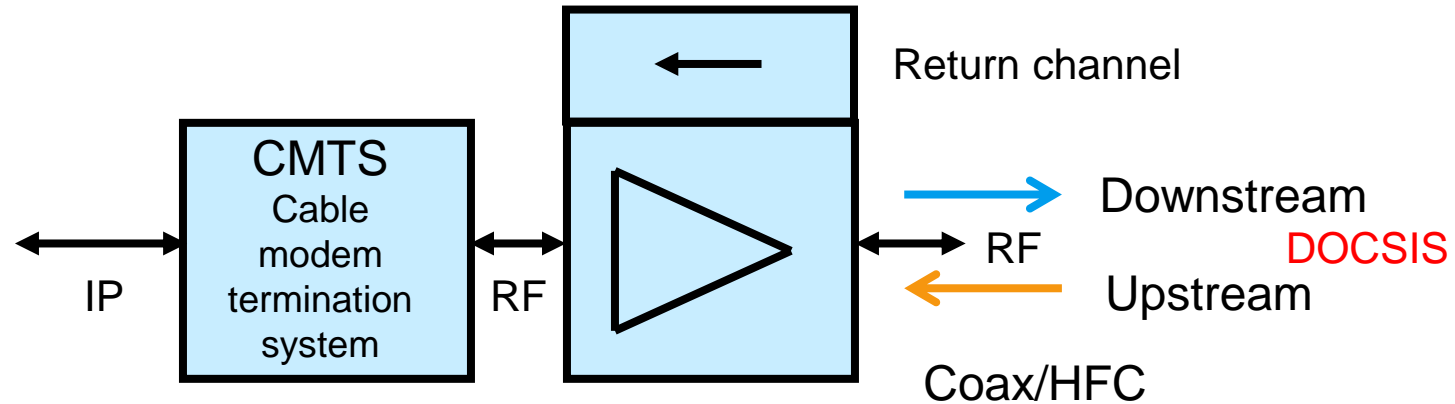

DOCSIS – Data-over-Cable Service Interface Specification

DOCSIS – Data over Cable Service Interface Specification

DOCSIS 1.0	1997 Cable Labs, ITU-T spec. ITU-T J.112
DOCSIS 1.1	1999 QoS capabilities
DOCSIS 2.0	2001 enhanced upstream speeds ITU-T J.122
DOCSIS 3.0	2006 increase of both up and downstream speed, IPv6 ITU-T J.222
DOCSIS 3.1	2013 10Gbit/s downstream, 1Gbit/s upstream, OFDM, 4096QAM

DOCSIS standard =
bidirectional transmission of high-speed data over
broadband cable networks using hybrid fiber-coaxial infrastructure

all DOCSIS standards are backward compatible

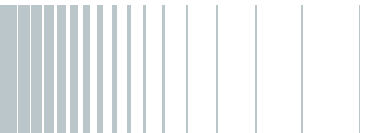

DOCSIS Physical Layer

DOCSIS 1.0 ... 3.0:

Downstream =

ITU-T J83B [US] Single Carrier 64QAM/256QAM

or

ITU-T J83A (DVB-C) [EURO-DOCSIS] Single Carrier 64QAM/256QAM

Upstream = Single Carrier, QPSK ... 64QAM, TDMA, CDMA

DOCSIS 3.1:

Downstream = **OFDM**, 4096 (4K) QAM and higher (16K QAM)

4K/8K OFDM, 50/25 kHz carrier distance

Upstream = **OFDM**, minislots in time and frequency domain

up to 4096 (4K) QAM, 2K/4K OFDM, 50/25 kHz carrier distance



DOCSIS 1.0 ... 3.0 Downstream Data Rates

Standard	Data rate per down stream channel
DOCSIS, J83B, 64QAM, 6 MHz	26.97 Mbit/s
DOCSIS, J83B, 256QAM, 6 MHz	38.81 Mbit/s
EURO-DOCSIS, DVB-C, 64QAM, 8 MHz	38.15 Mbit/s
EURO-DOCSIS, DVB-C, 256QAM, 8 MHz	51 Mbit/s



Single Carrier Modulation Principle

DOCSIS Intro and Principle

Single Carrier Modulation Principle

Time Domain and Spectrum Domain

QAM and SNR Requirement

OFDM in CATV

DOCSIS 3.1 Physical Layer Parameters

DOCSIS 3.1 Demo Transmission



IQ Modulator / Single Carrier Modulation

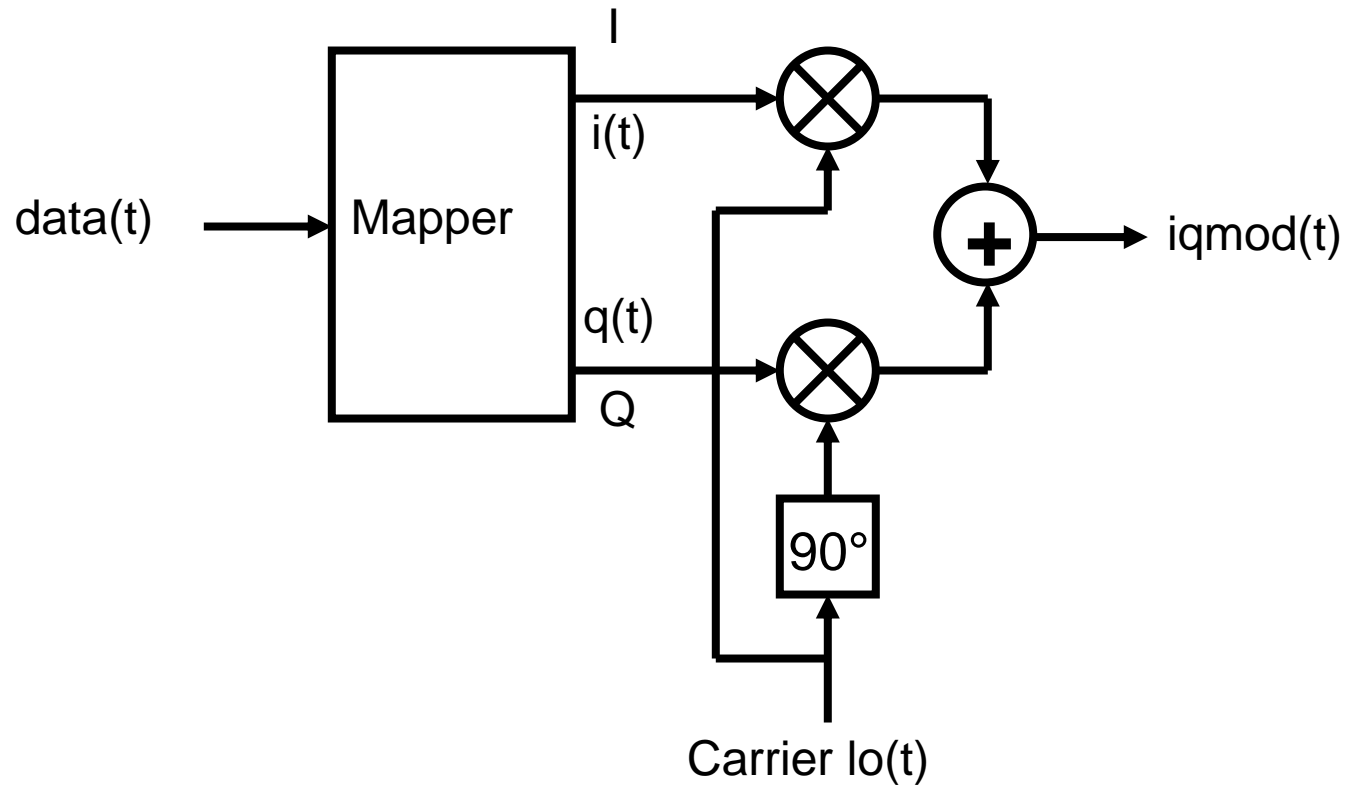

Single Carrier Modulation ... very short Symbols

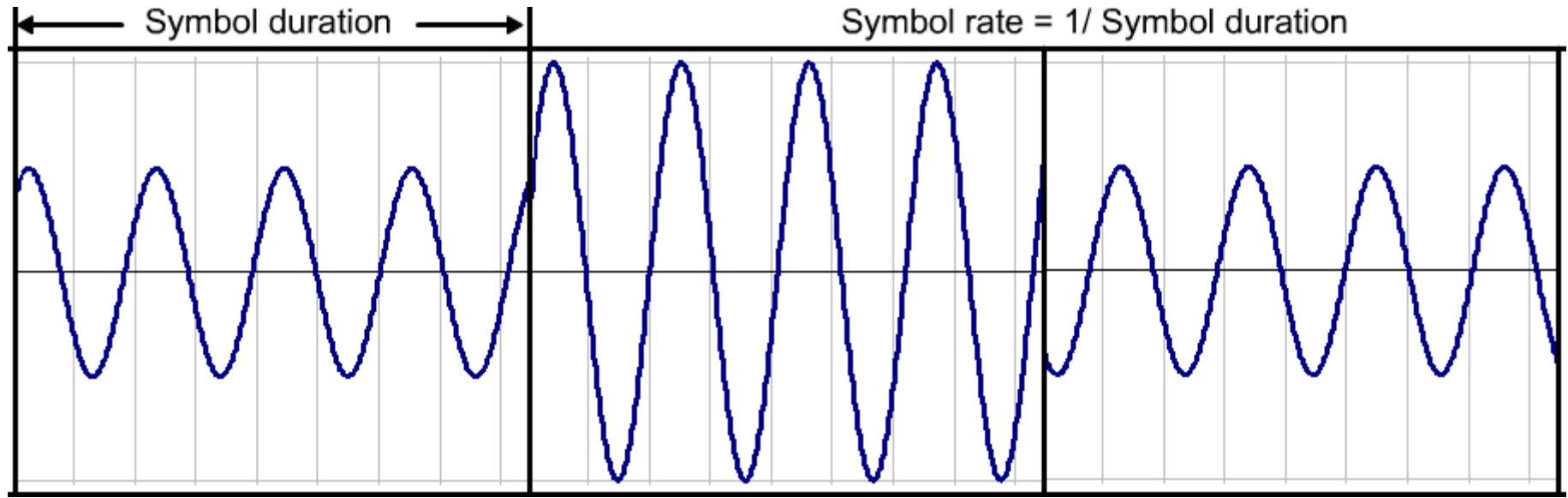

Example: DVB-C, 6.9 MS/s; Symbol duration = $1/6.9 \mu\text{s} = 144 \text{ ns}$

(... DOCSIS3.1 symbol duration ... 20 or 40 μs ... OFDM, 1...5 μs guard)

Constellations QPSK, 16QAM, 64QAM, 256QAM

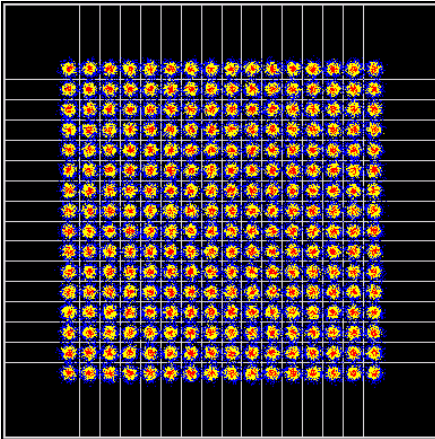
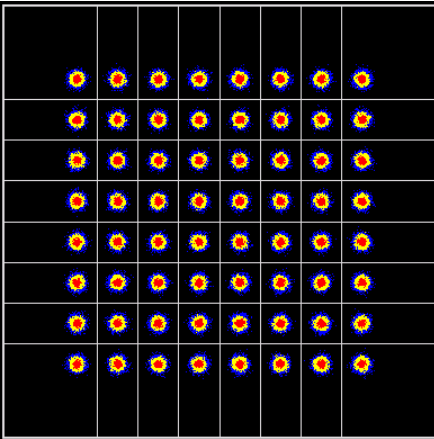
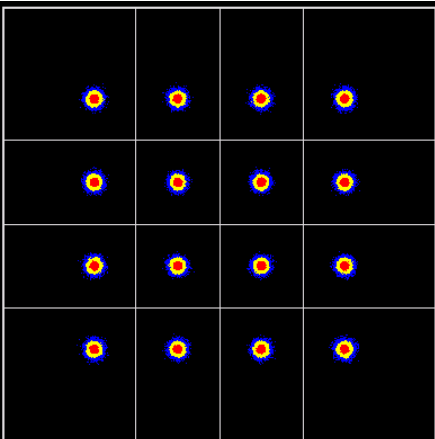
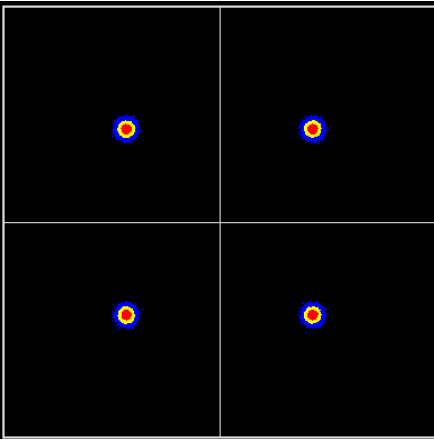

DVB-C FEC

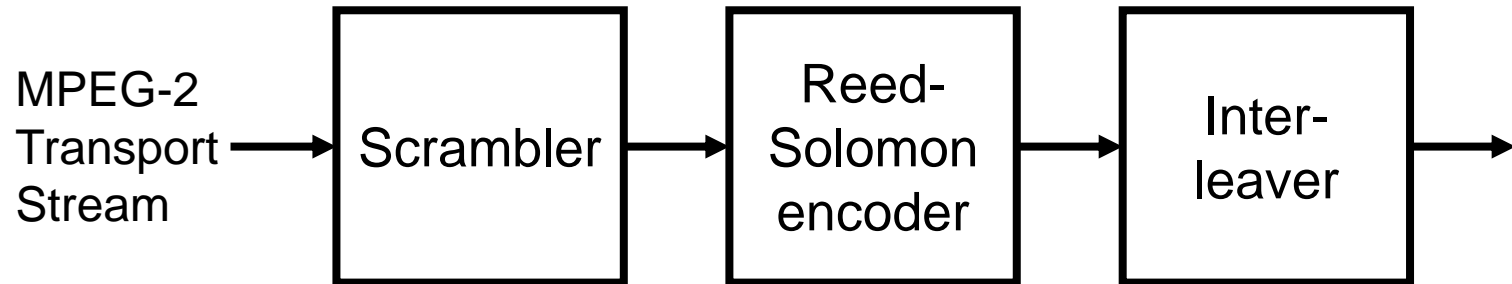

Time Domain and Spectrum Domain

DOCSIS Intro and Principle

Single Carrier Modulation Principle

Time Domain and Spectrum Domain

QAM and SNR Requirement

OFDM in CATV

DOCSIS 3.1 Physical Layer Parameters

DOCSIS 3.1 Demo Transmission



Continuous Streams and Bursted Streams

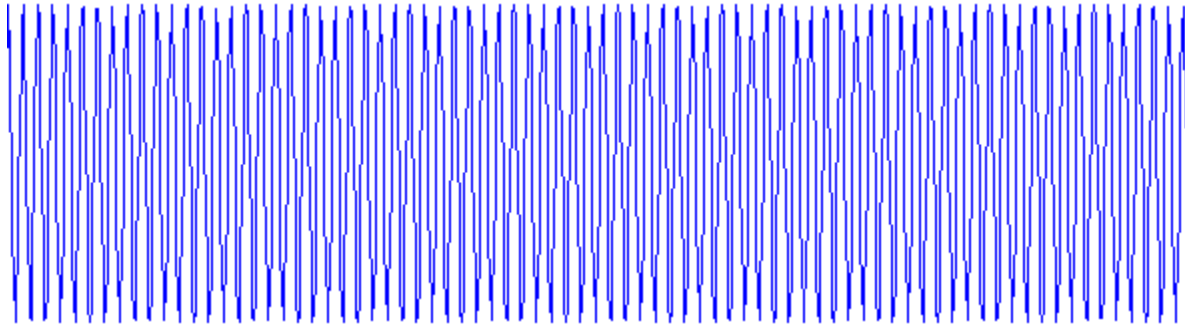

Downstream

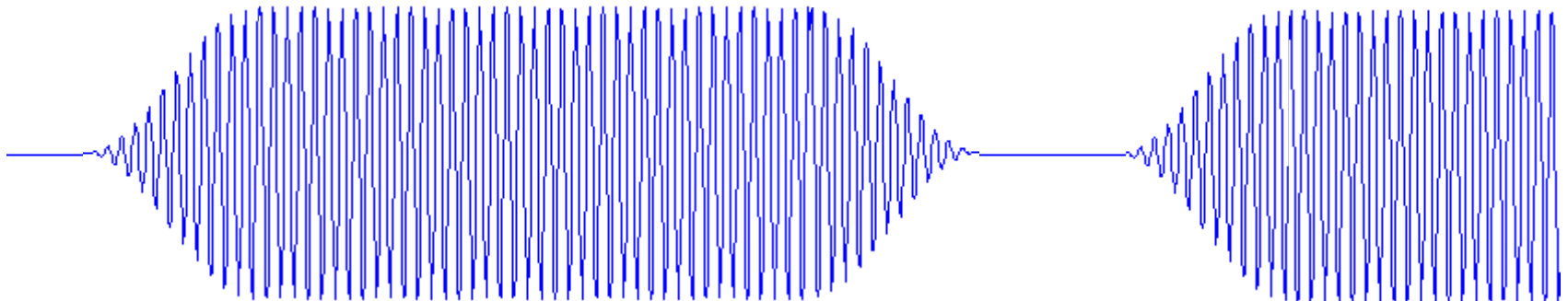

Upstream

Spectral Rolloff Filtering in DVB-C ($r=0.15$)

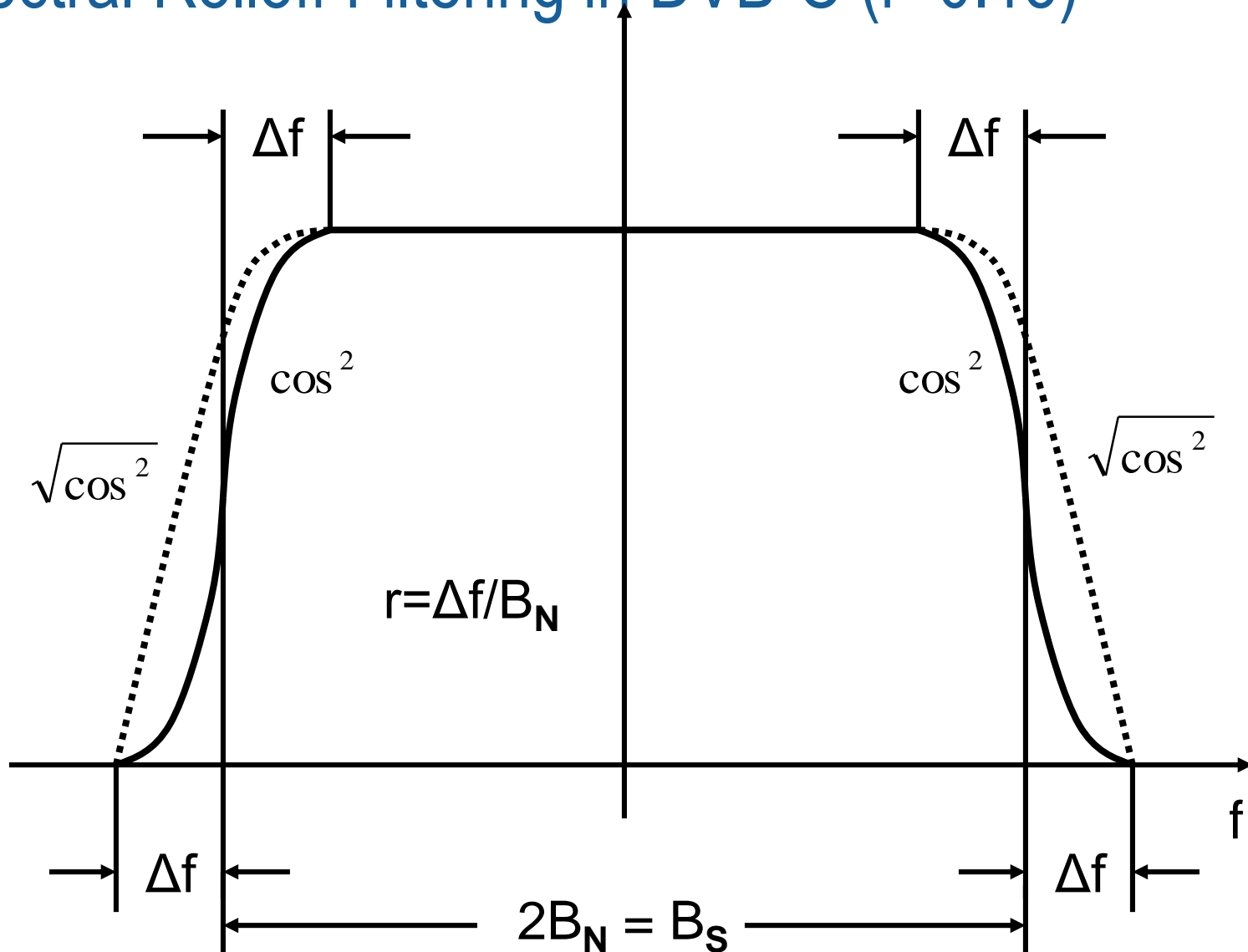

Spectrum, CATV Network

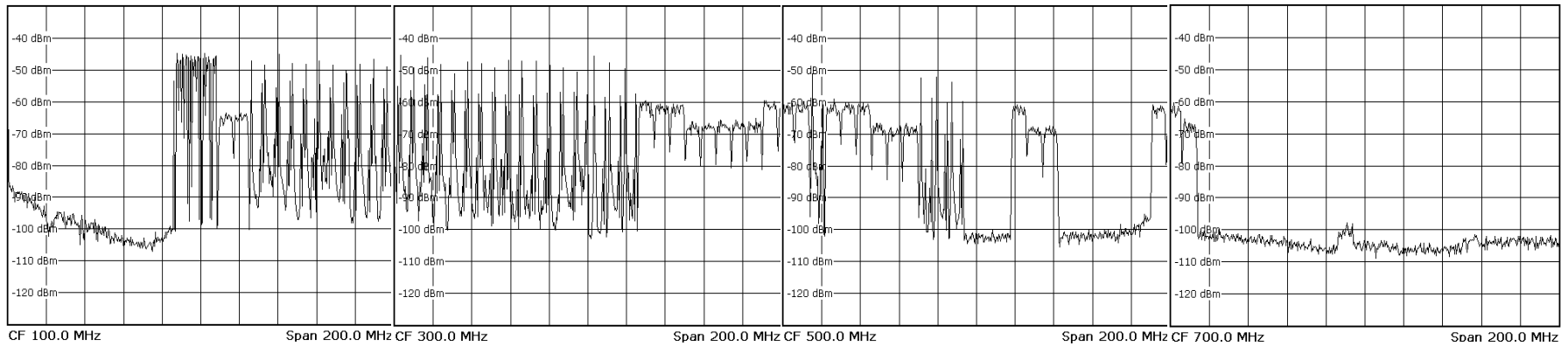

RF Characteristics

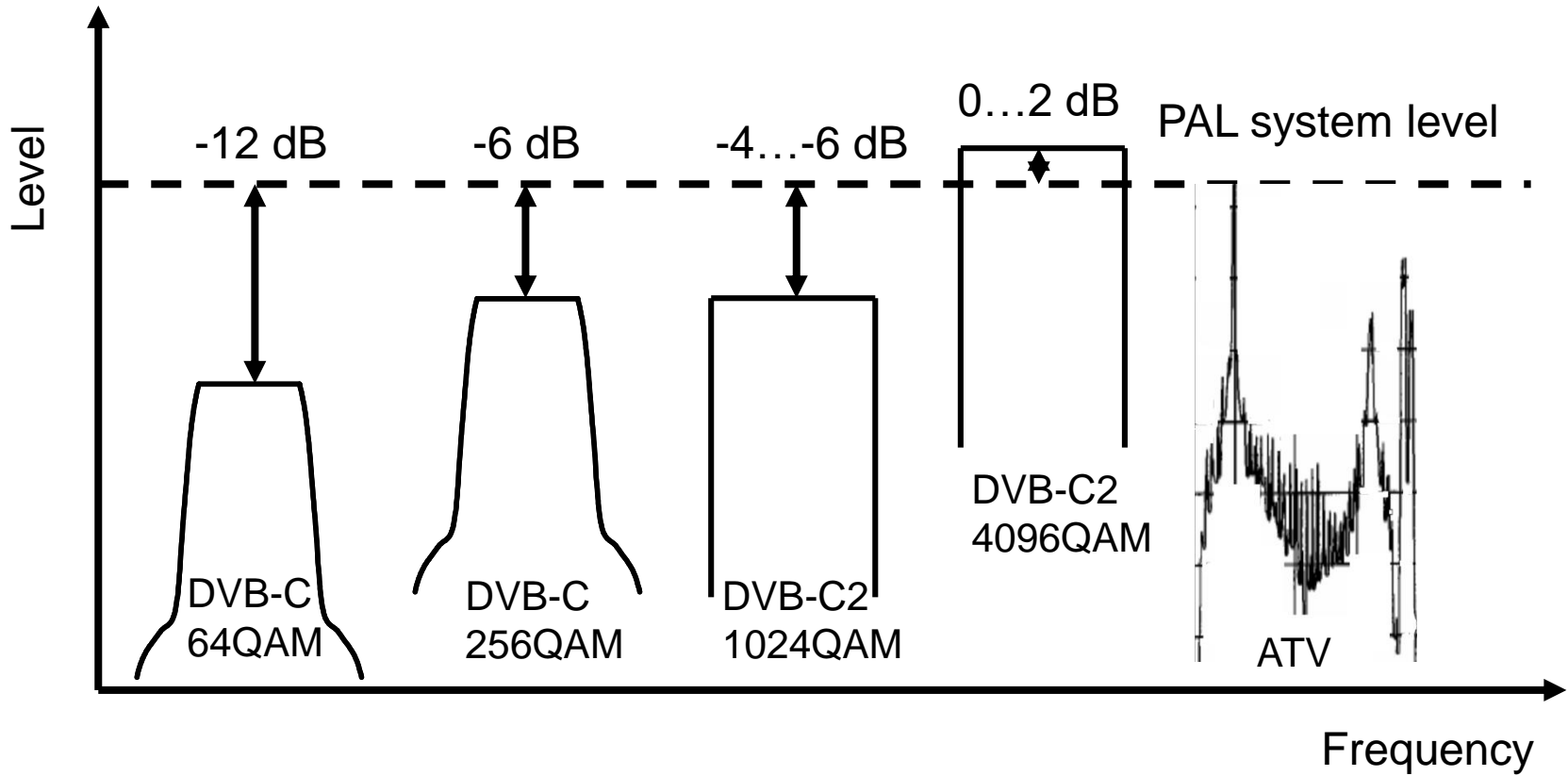

QAM and SNR Requirement

DOCSIS Intro and Principle

Single Carrier Modulation Principle

Time Domain and Spectrum Domain

QAM and SNR Requirement

OFDM in CATV

DOCSIS 3.1 Physical Layer Parameters

DOCSIS 3.1 Demo Transmission



Required SNR(QAM Order)

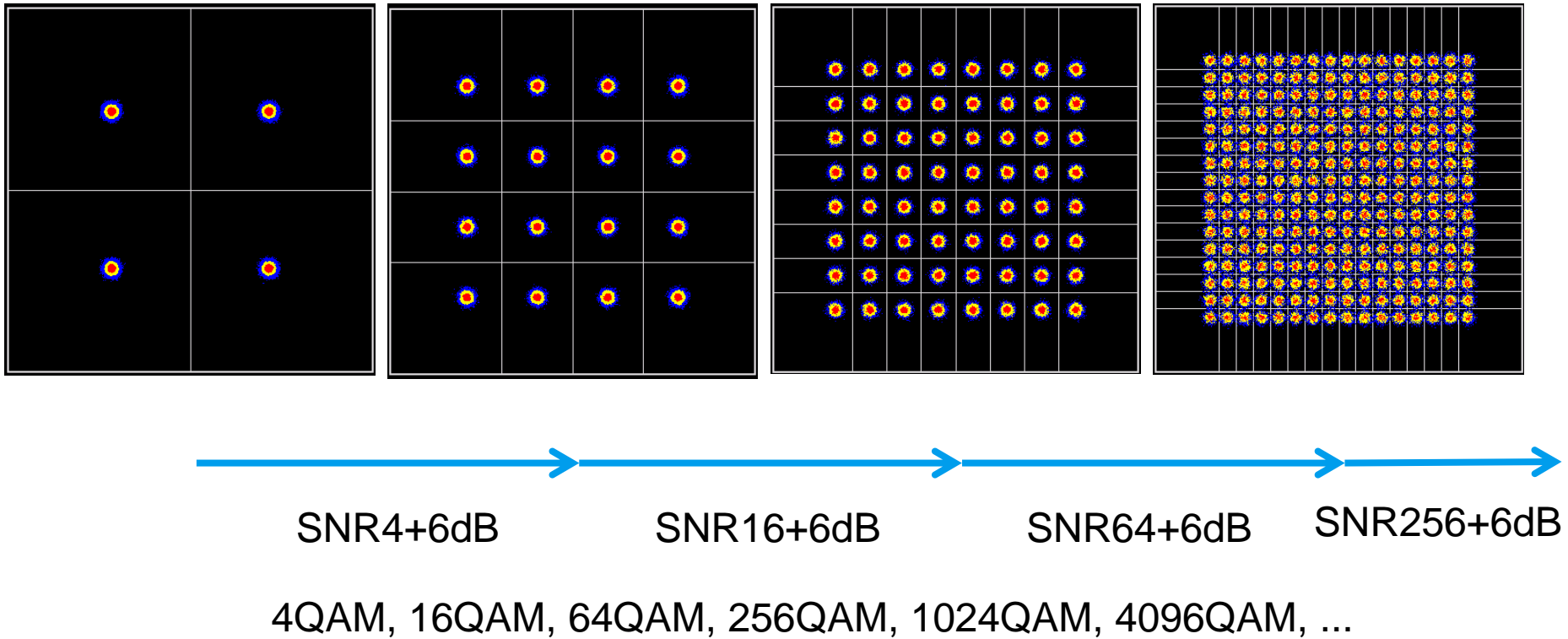

Mainly used Modulation in Cable: 64QAM, 256QAM

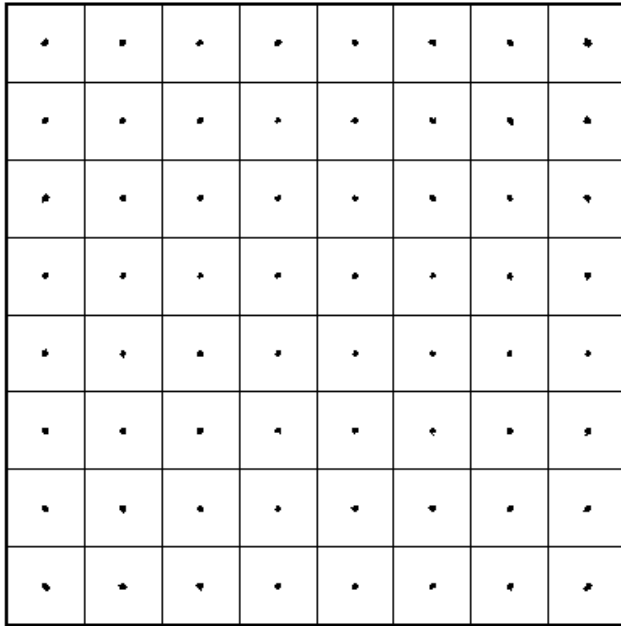

64QAM

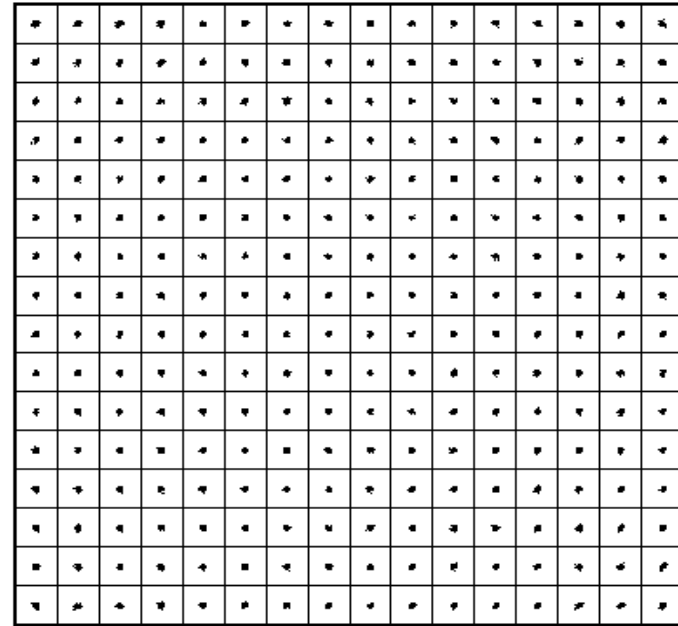

256QAM



$$\text{SNR}_{64} + 6\text{dB} = \text{SNR}_{256}$$



OFDM Basics, OFDM in CATV

DOCSIS Intro and Principle

Single Carrier Modulation Principle

Time Domain and Spectrum Domain

QAM and SNR Requirement

OFDM in CATV

DOCSIS 3.1 Physical Layer Parameters

DOCSIS 3.1 Demo Transmission



Interferences in a CATV Network

- Linear distortions (amplitude response, group delay)
- Non-linear distortions (... amplifiers ...)
- Intermodulation (multi-channel load and non-linearity)
- Short echos (micro-reflections)
- Noise (AWGN)
- Noise, frequency selective interferer
- Ingress noise
- Leakage (in both directions ...)
- ...



Amplitude Response in CATV - Tilt

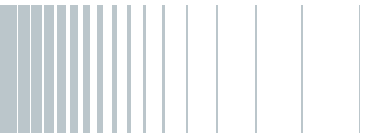
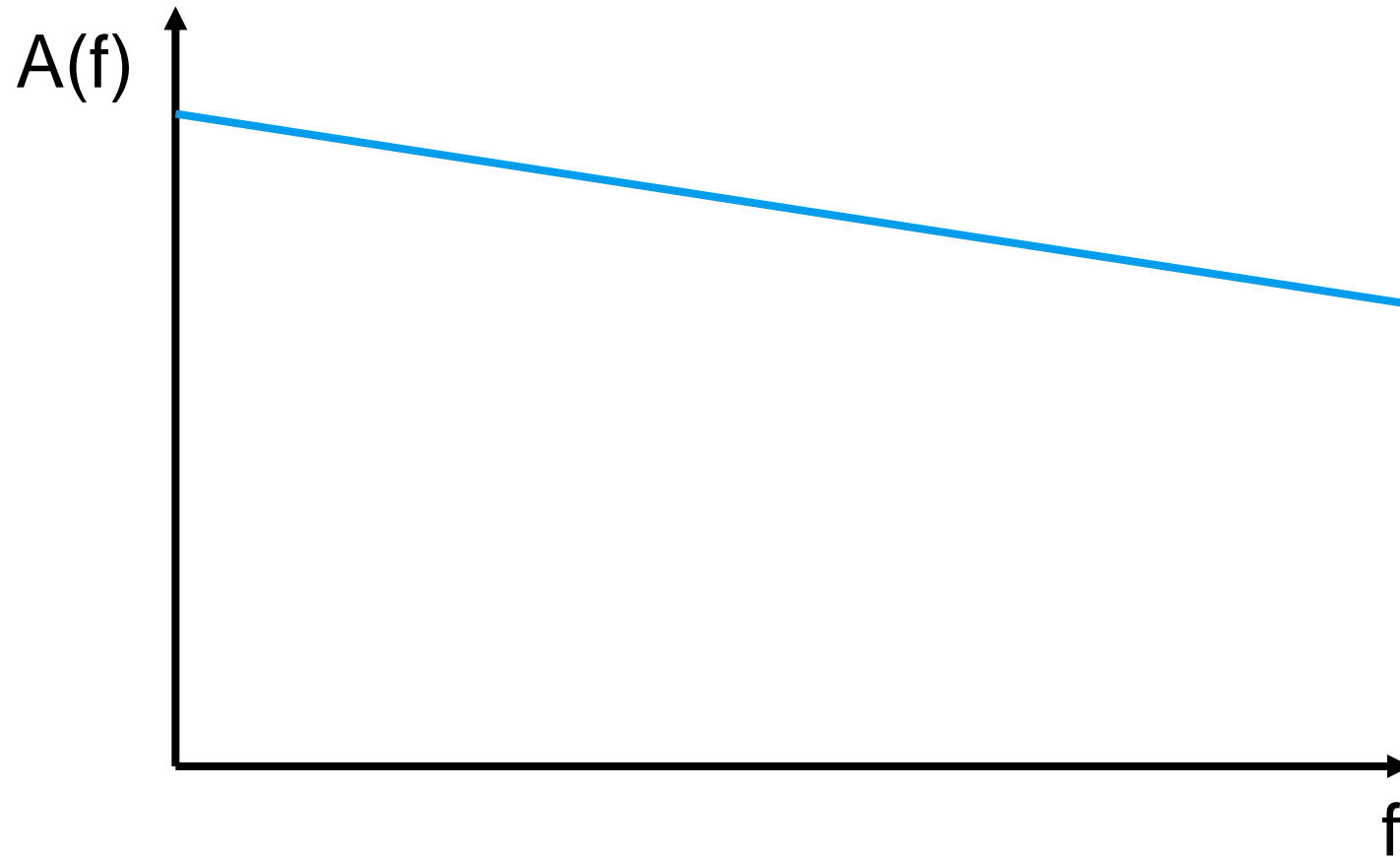

Interferer in CATV (Ingress, DVB-T/T2 Interferer, ...)

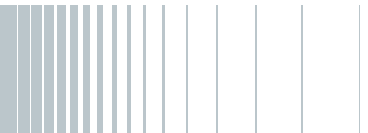
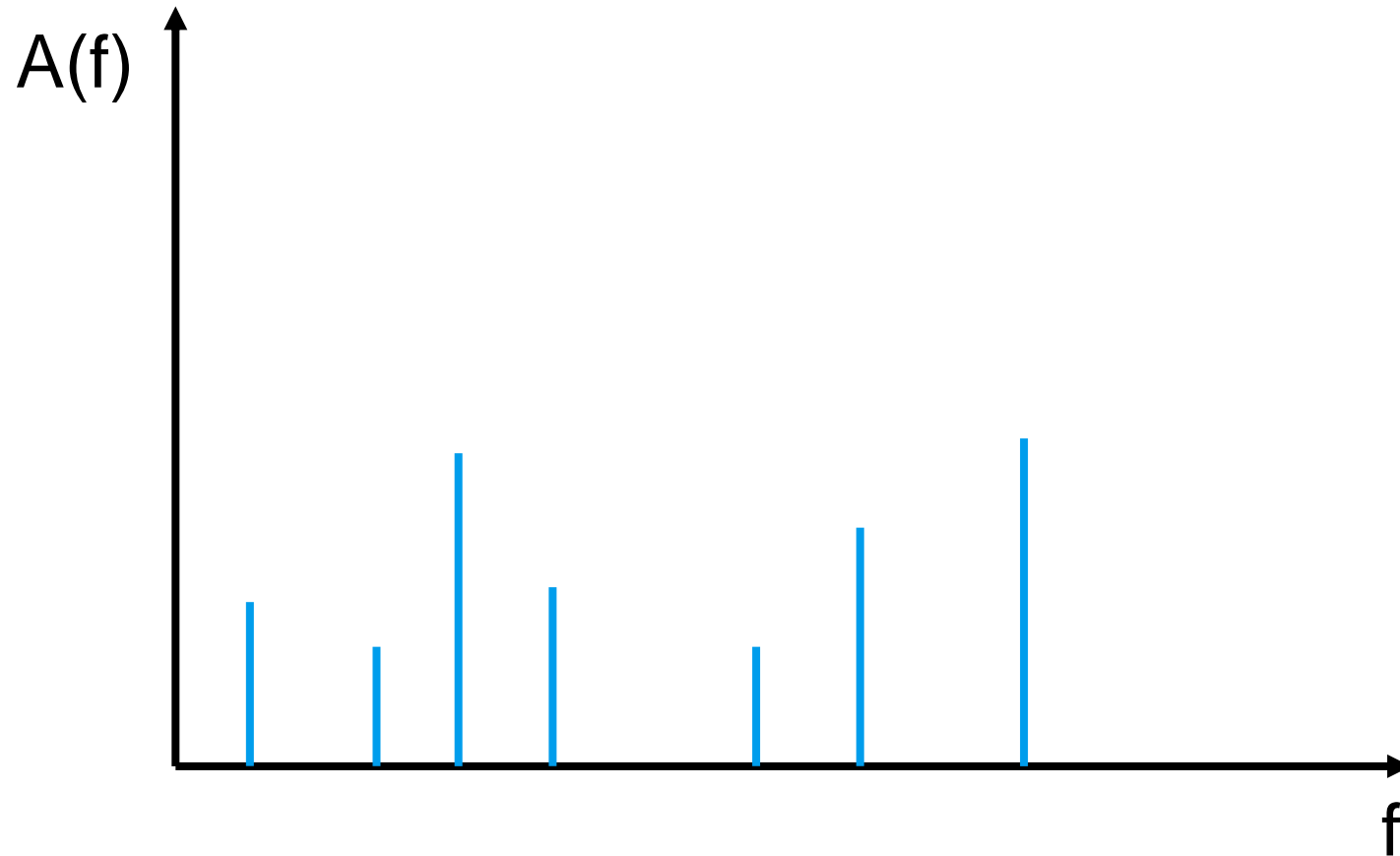

Unused, ... Forbidden Frequencies ... in CATV („Notches“)

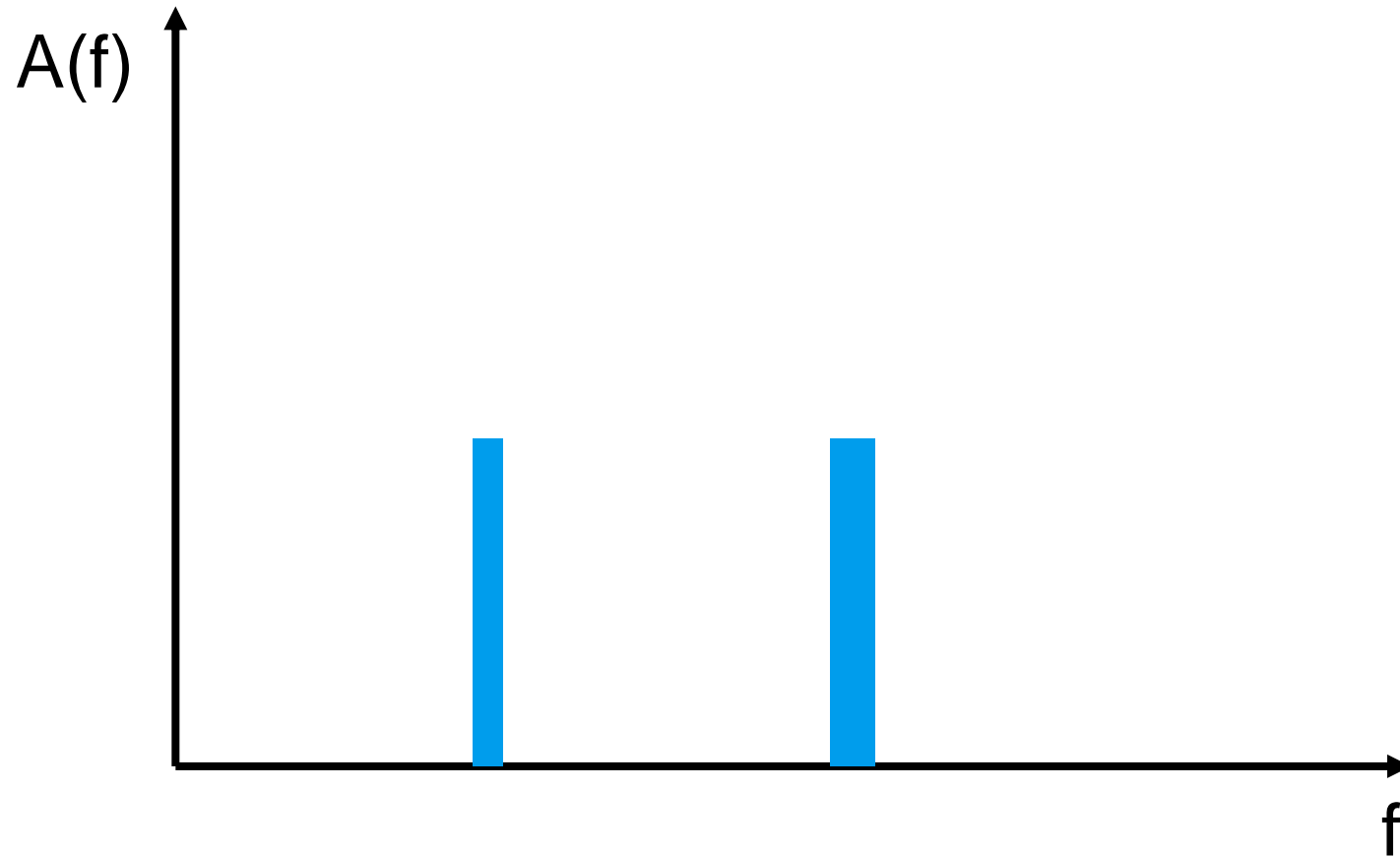

OFDM – Orthogonal Frequency Division Multiplex

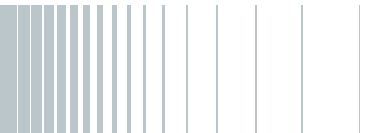
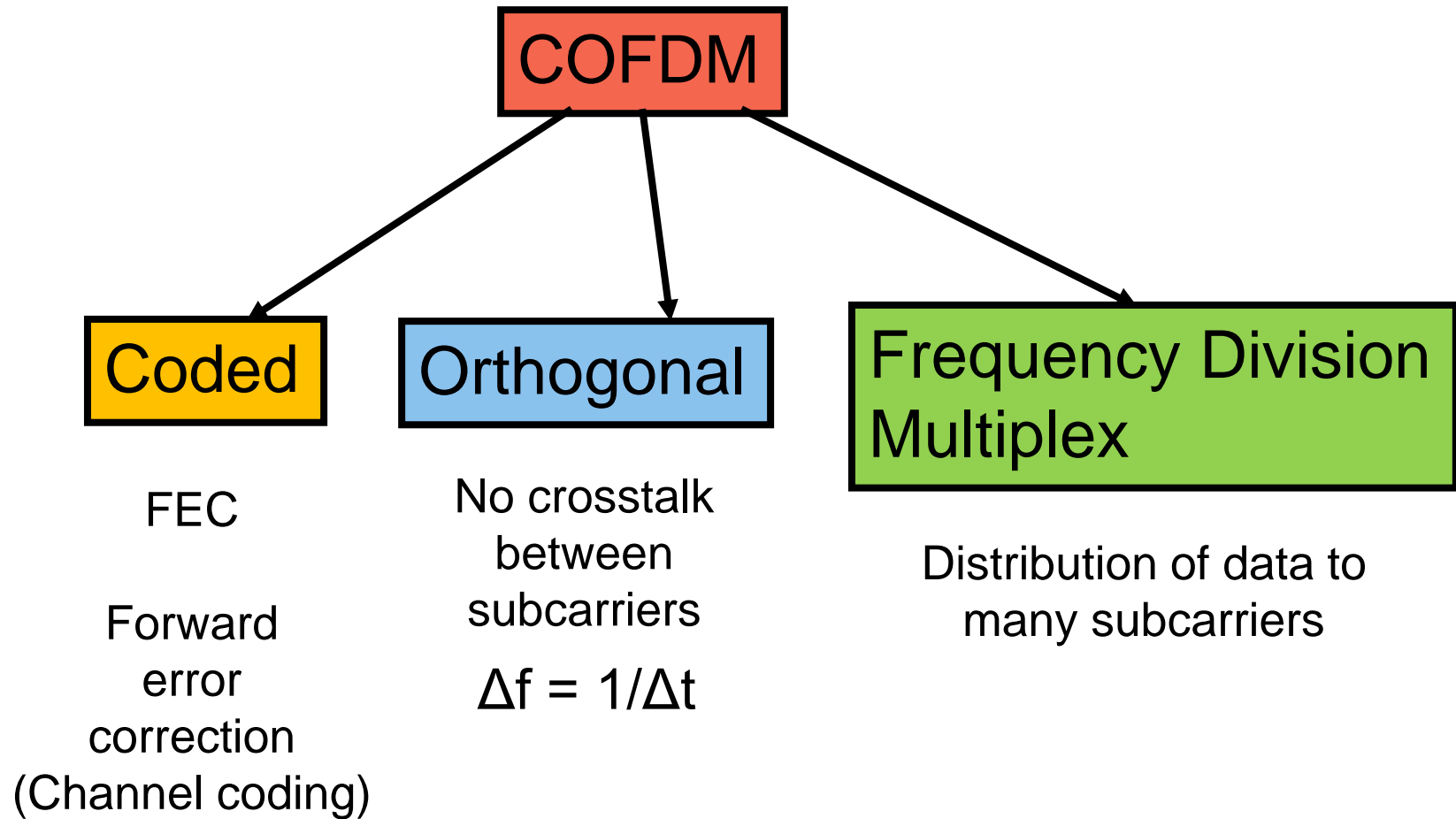

COFDM Principle

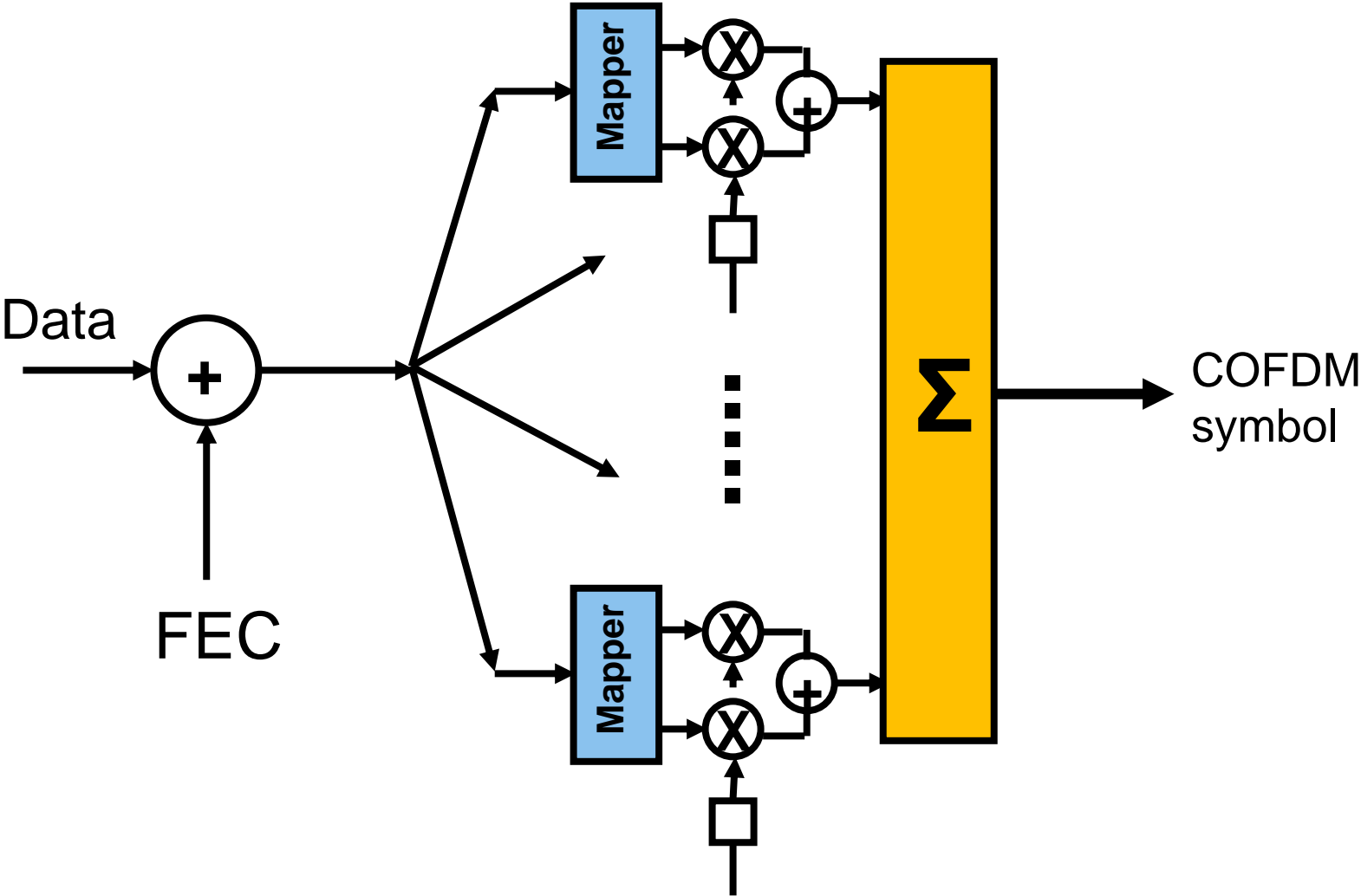

Mapping of OFDM carrier

Data stream: 0110 1110 0001 1010 1111 0011 0000 1010 0101

Forming of groups of 4 bit at 16QAM

carrier no. 0 1 2 3 4 5 6 7 8

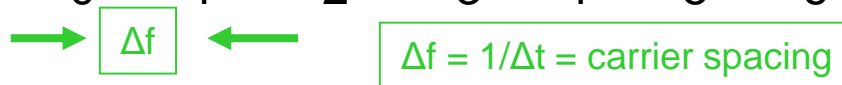

mapped carrier vector

each carrier is described via a (I,Q) pair in the frequency domain

each carrier corresponds to a narrow-band modulated transmission channel

at DVB-T: 6817 or 1705 carriers in a distance of approx. 1kHz or 4kHz
6817 or 1705 carrier plus guard band = 2^N carrier = 8192 or 2048 carrier

IFFT = Inverse Fast Fourier Transformation

OFDM symbol in time domain

IFFT and I/Q Modulator

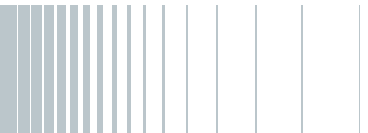
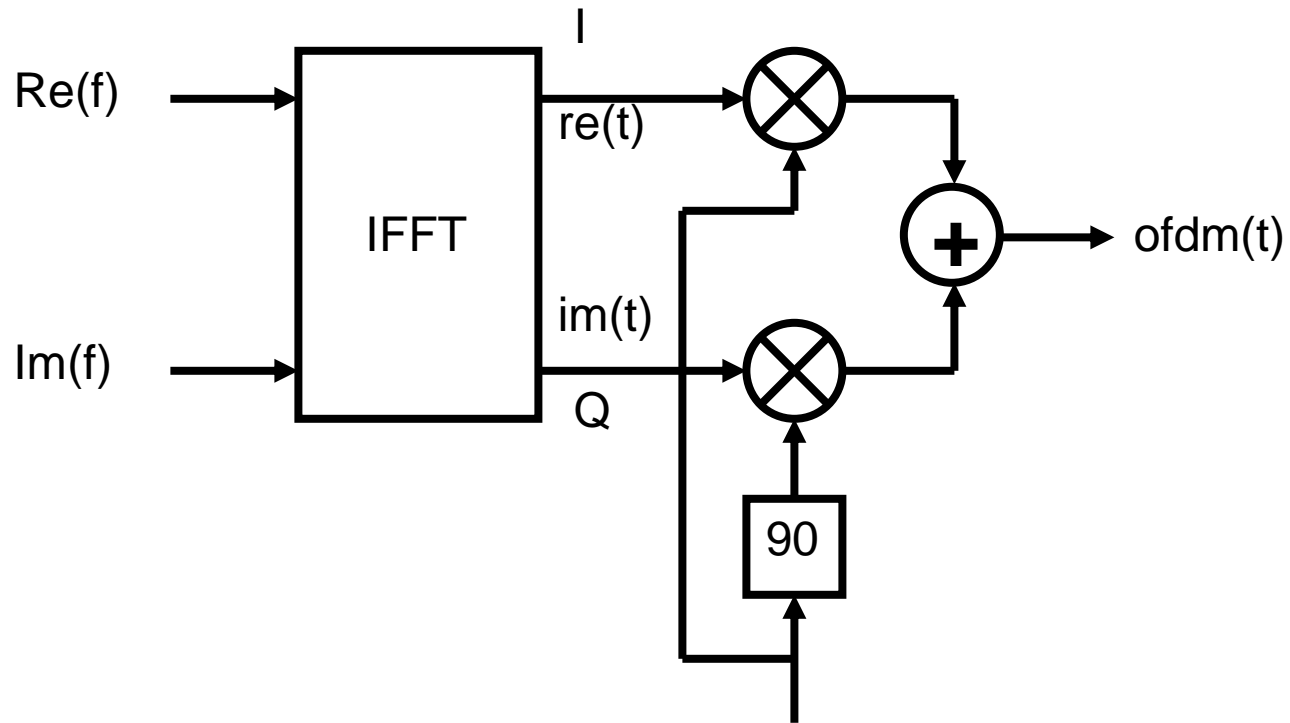

OFDM Symbols with Guard Interval

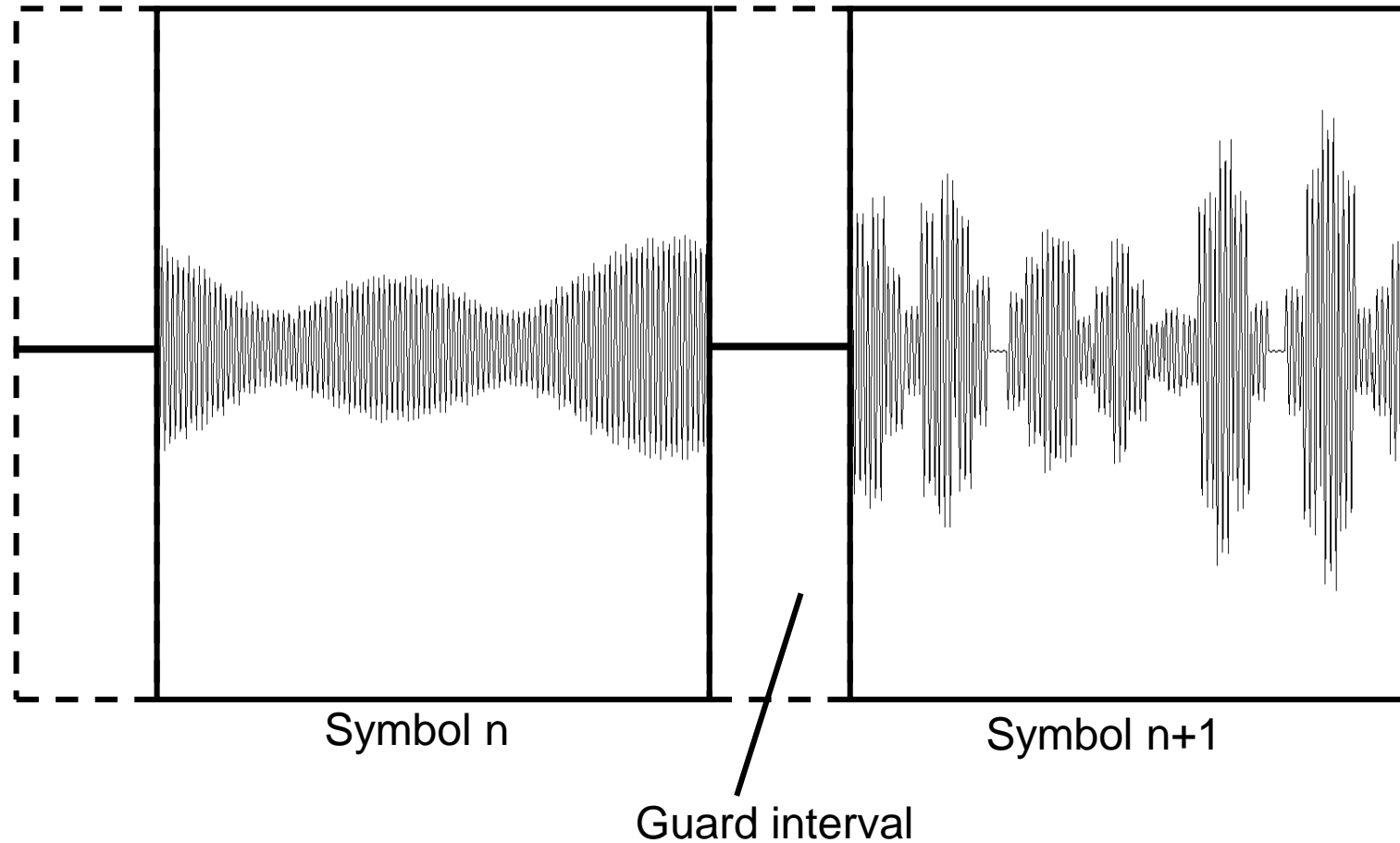

(... DOCSIS3.1 symbol duration ... 20 or 40 μs , 1...5 μs guard)

OFDM Symbols with Guard Interval

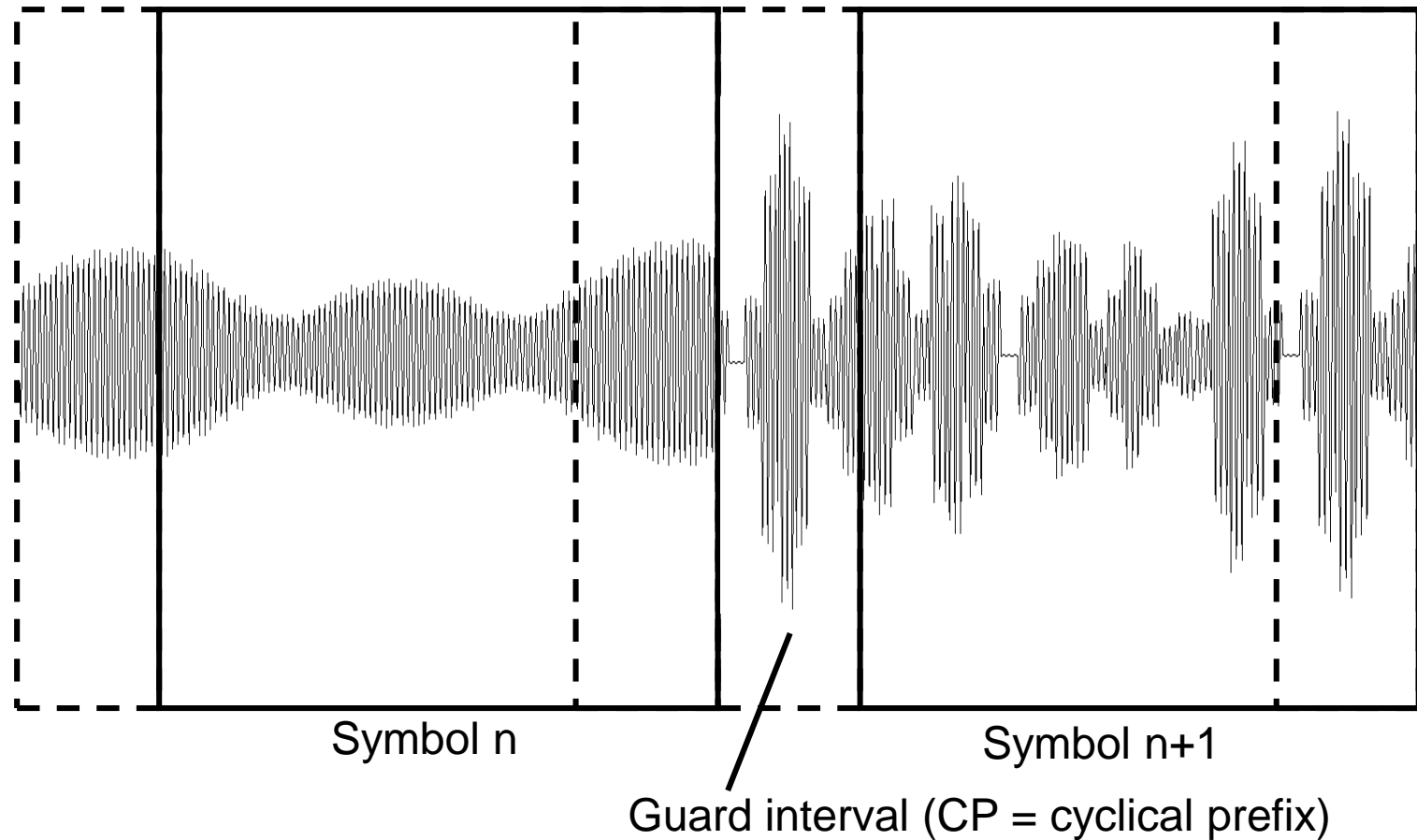

(... DOCSIS3.1 symbol duration ... 20 or 40 μs , 1...5 μs guard)

Guard Interval – Cyclical Prefix

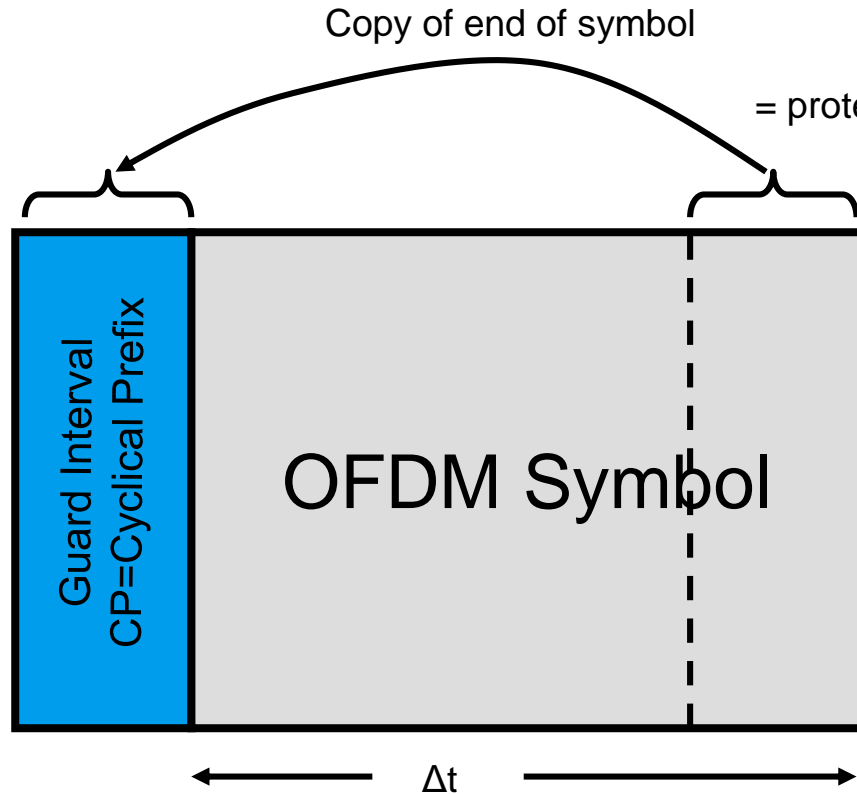

= protection against intersymbol interference
in OFDM systems

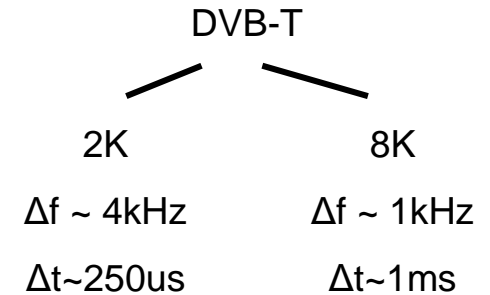

Symbol
duration
 $\Delta t = 1/\Delta f$

Guard interval = „quasi-break“ =

Mechanism against problems in time domain at multipath reception



Intersymbol Interference (ISI)

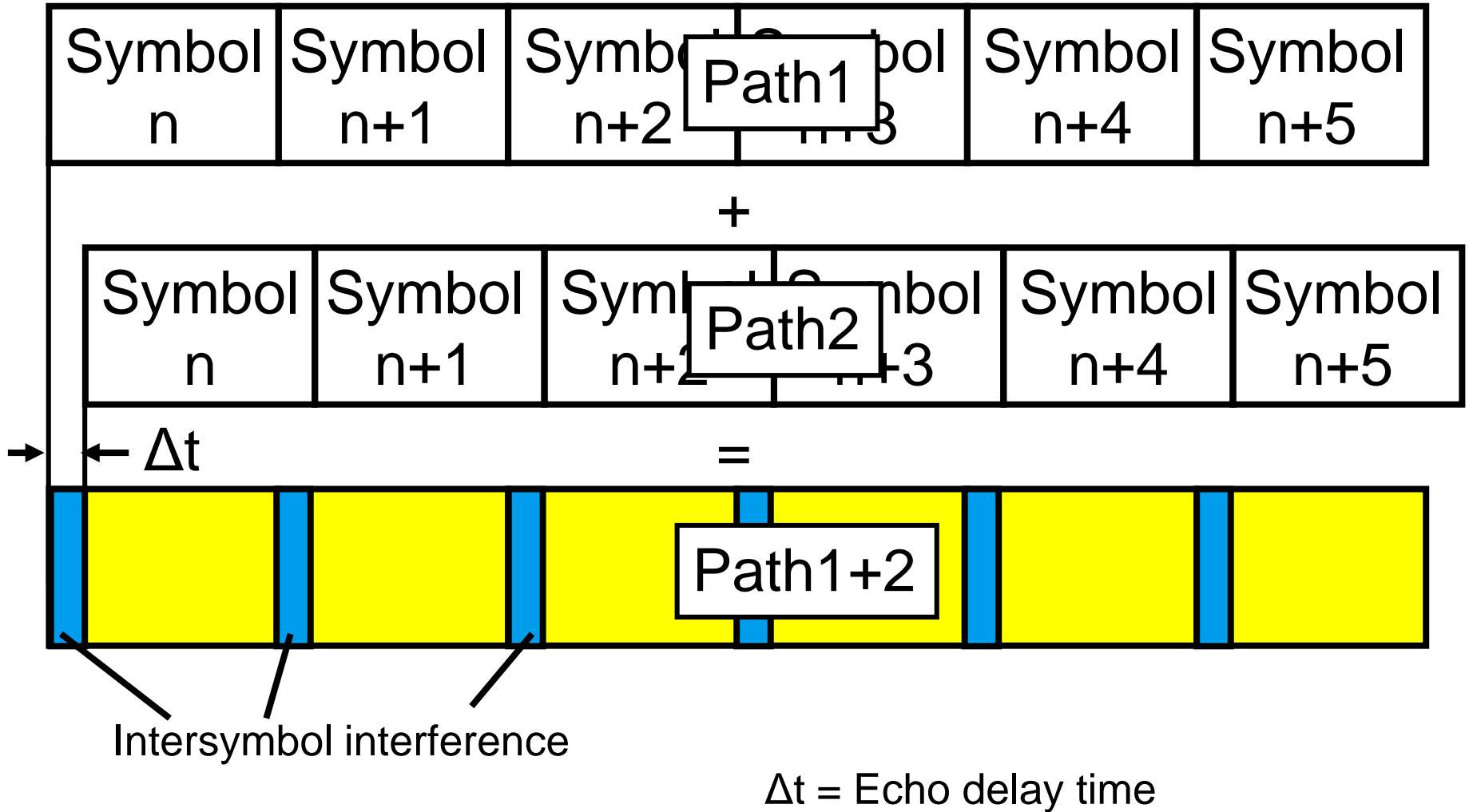

(Only) Micro Reflections in CATV

Micro-reflections in downstream
(DOCSIS 3.1)

Time	Attenuation
$\leq 0.5 \mu\text{s}$	-20 dBc
$\leq 1.0 \mu\text{s}$	-25 dBc
$\leq 1.5 \mu\text{s}$	-30 dBc
$> 2.0 \mu\text{s}$	-35 dBc
$> 3.0 \mu\text{s}$	-40 dBc
$> 4.5 \mu\text{s}$	-45 dBc
$> 5.0 \mu\text{s}$	-50 dBc

Micro-reflections in upstream
(DOCSIS 3.1)

Time	Attenuation
$\leq 0.5 \mu\text{s}$	-16 dBc
$\leq 1.0 \mu\text{s}$	-22 dBc
$\leq 1.5 \mu\text{s}$	-29 dBc
$> 2.0 \mu\text{s}$	-35 dBc
$> 3.0 \mu\text{s}$	-40 dBc
$> 4.5 \mu\text{s}$	-42 dBc
$> 5.0 \mu\text{s}$	-51 dBc

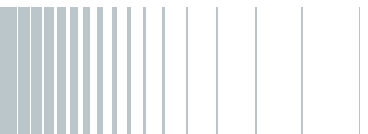

OFDM Spectrum

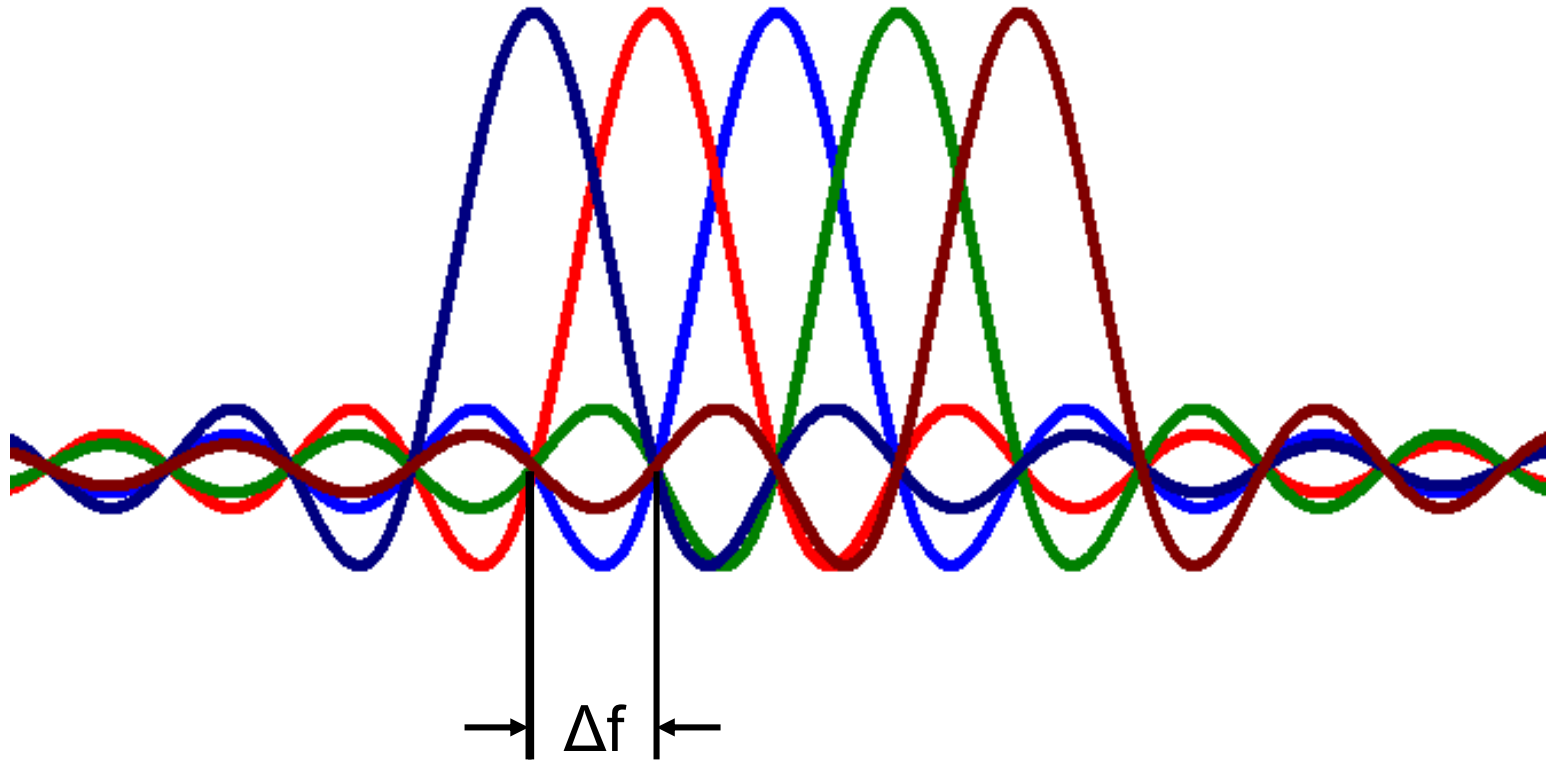

Orthogonality

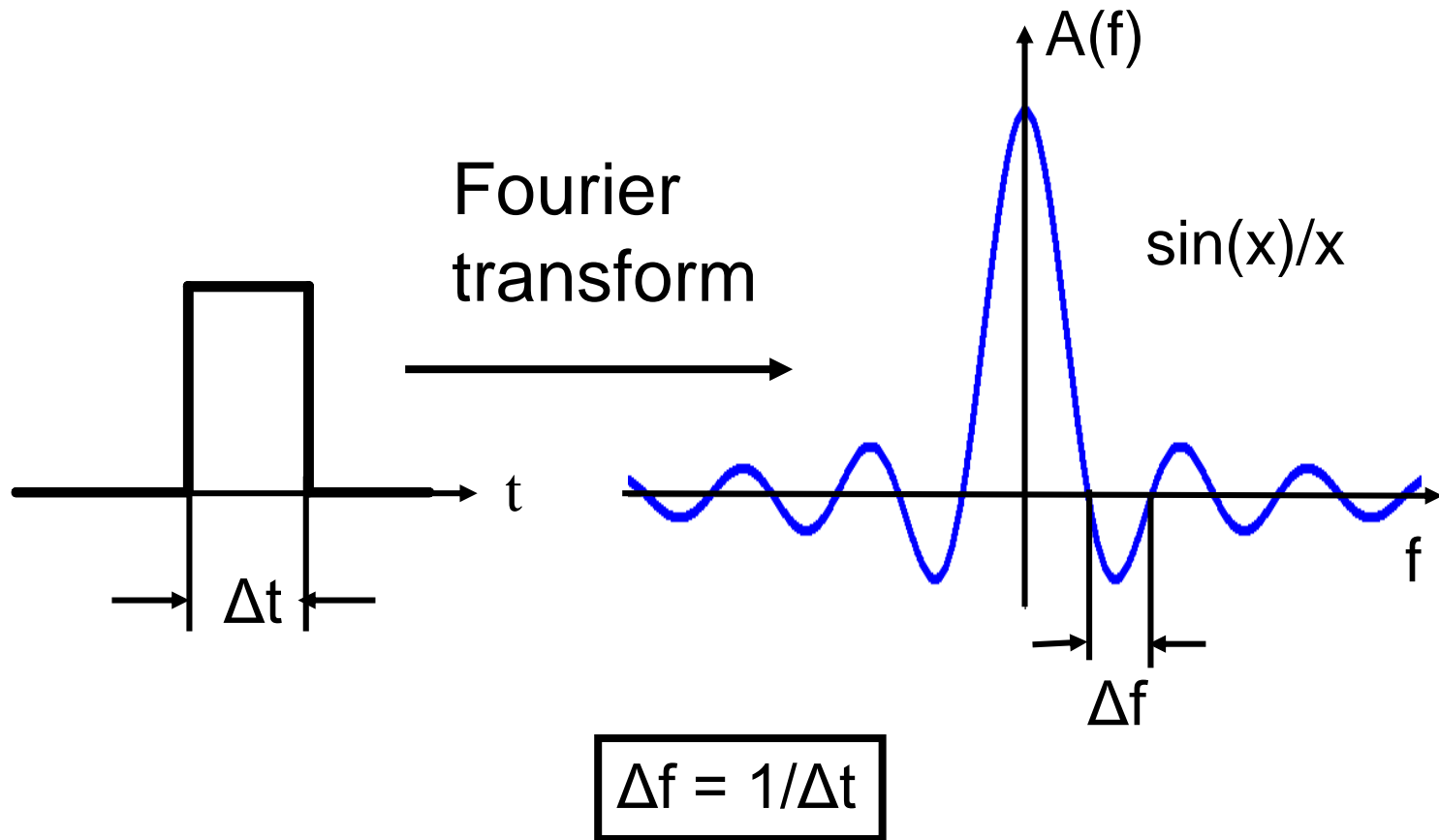

OFDM Spectrum

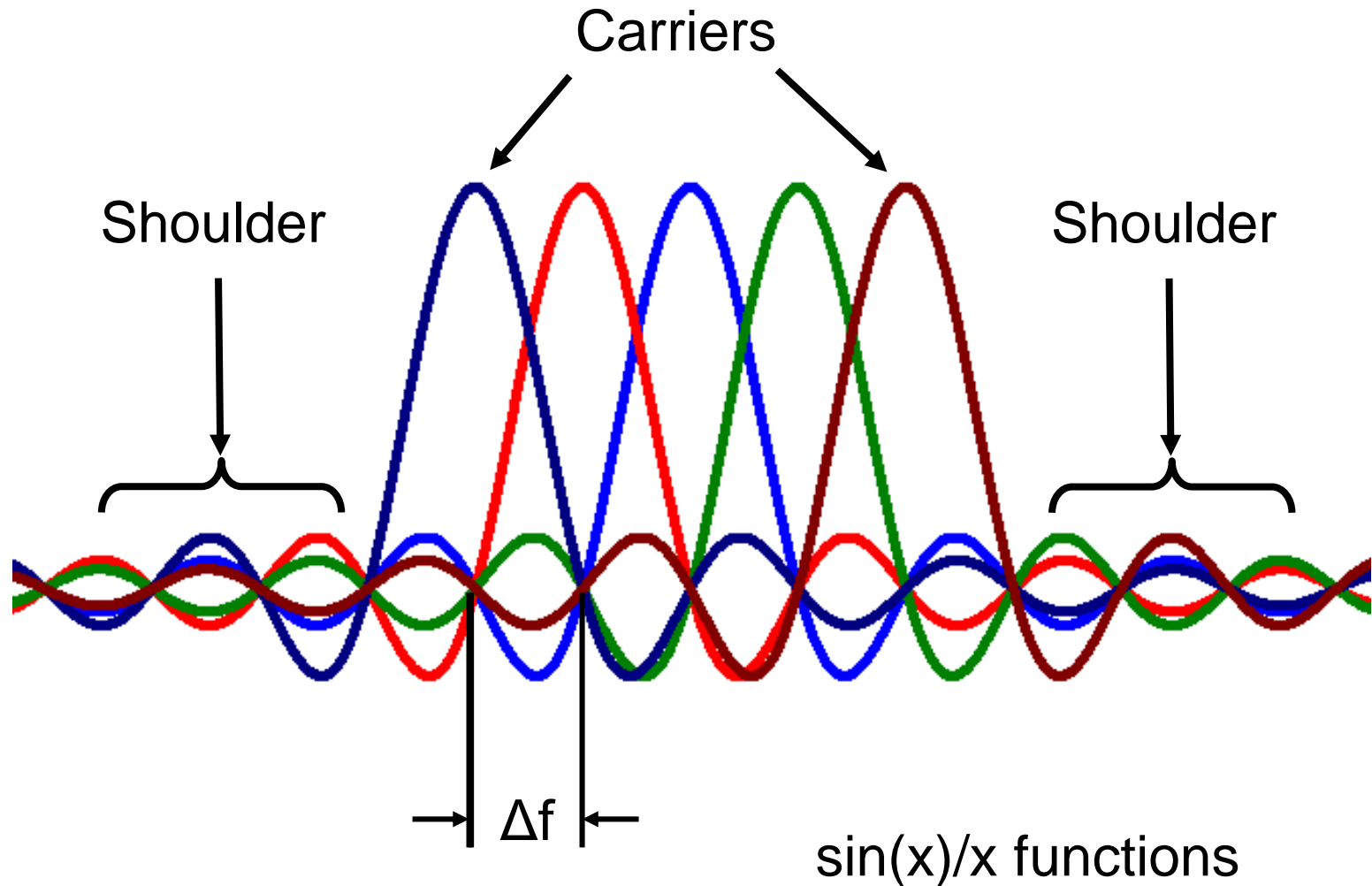

(... DOCSIS3.1 carrier distance ... 25 or 50 kHz)



OFDM Spectrum

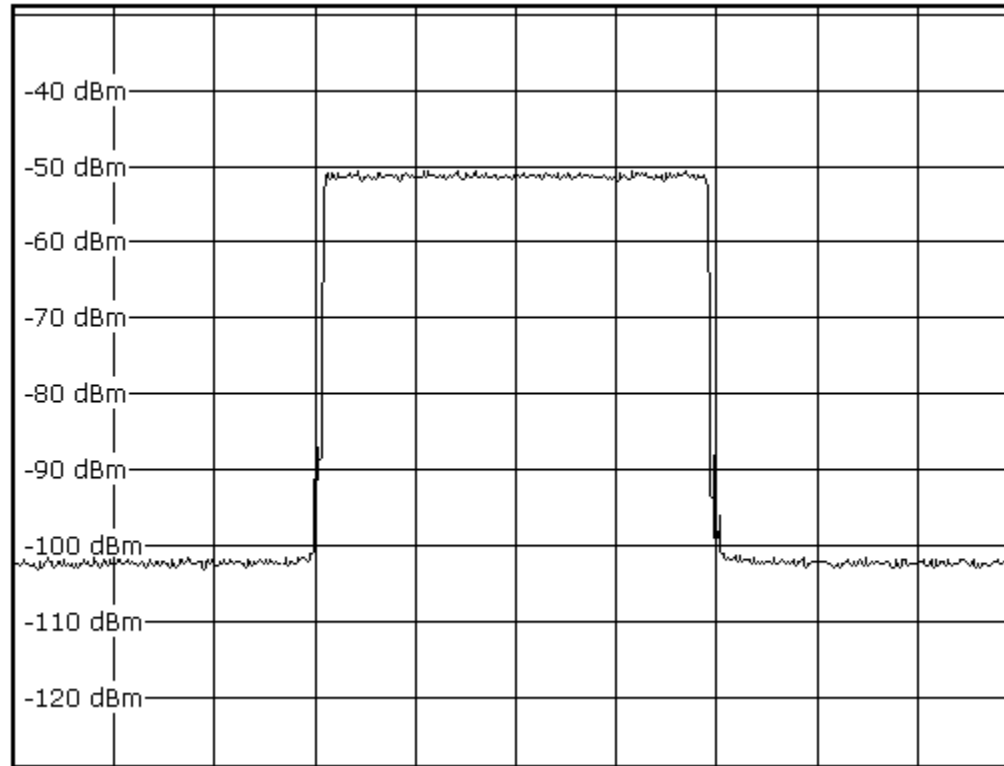

OFDM – Edge Carriers switched off

„Guard band“

2^N carrier, but edge carriers are switched off: guard band to attenuate the shoulders of the OFDM spectrum

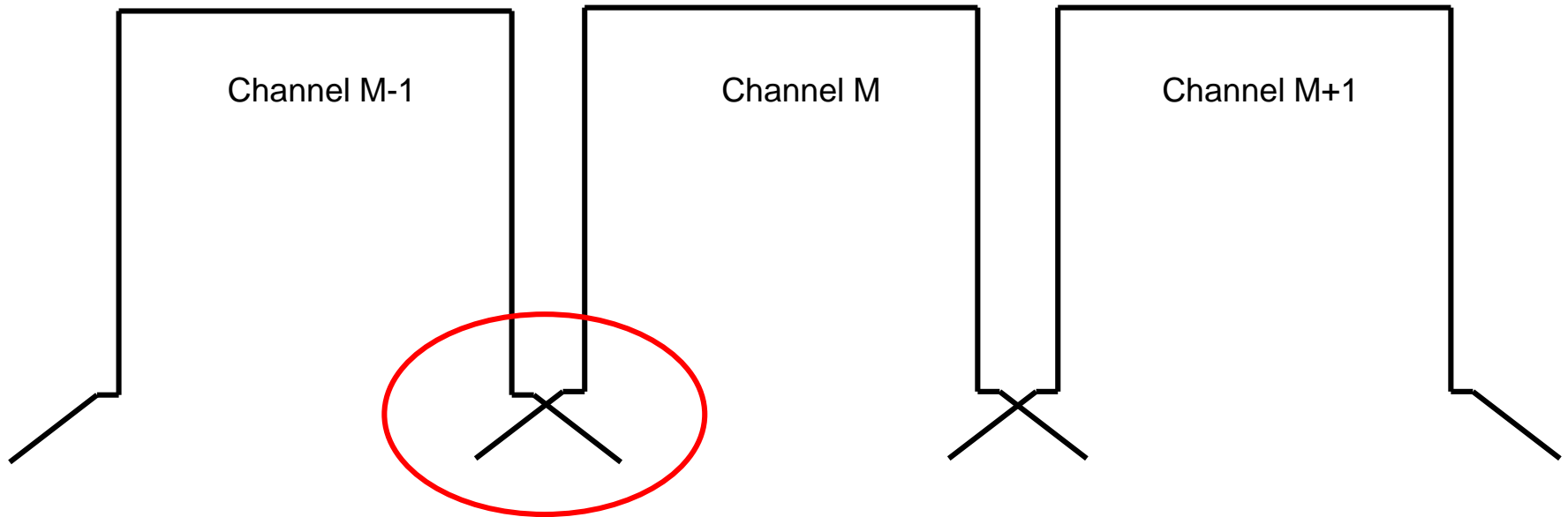

Shoulders of OFDM spectrum



OFDM-Symbol

modulated OFDM carriers in time domain,
discrete carriers ...

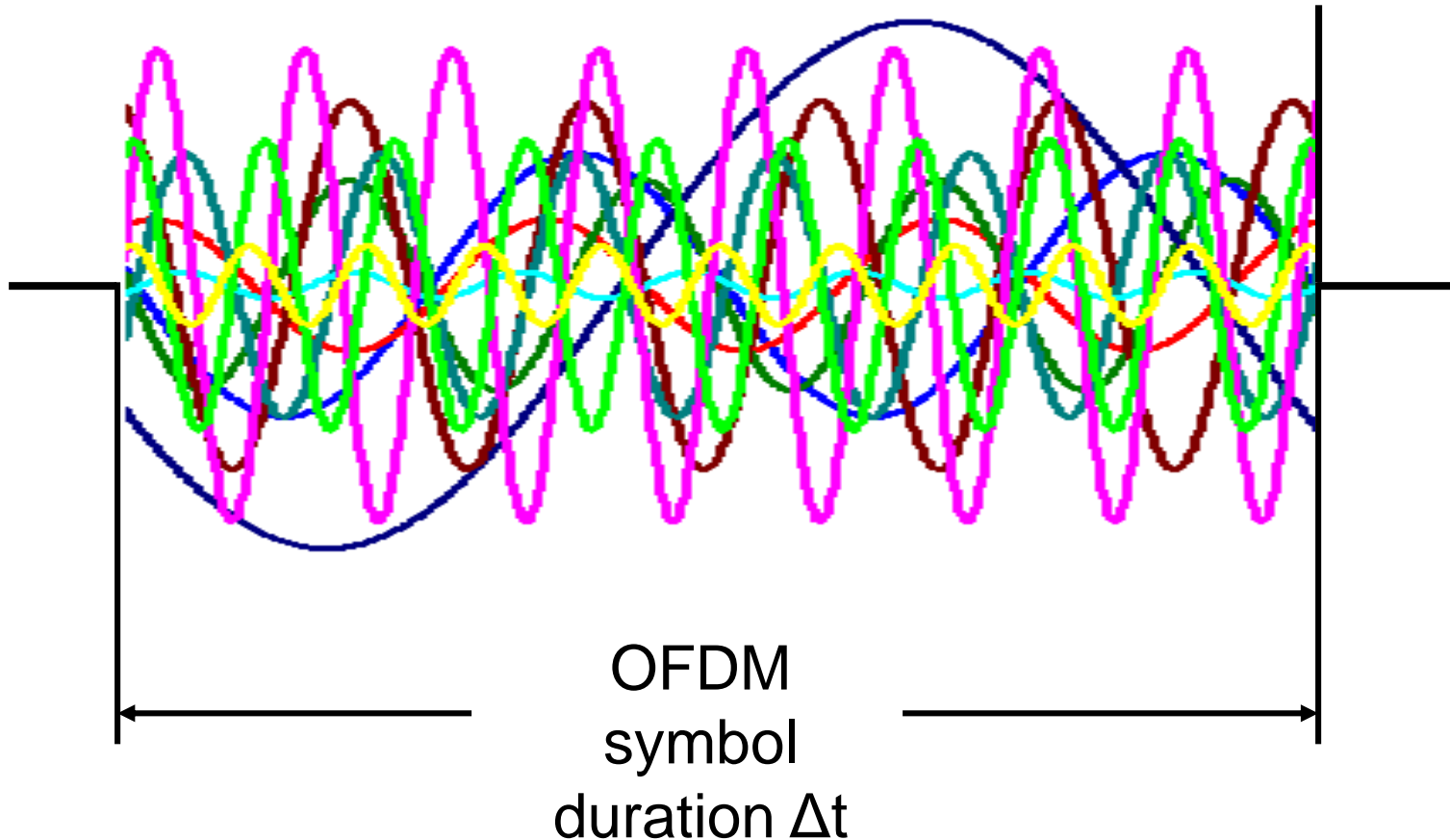

(... DOCSIS3.1 symbol duration ... 20 or 40 μs , 1...5 μs guard)

OFDM Symbol

OFDM carriers, in time domain, overlaid

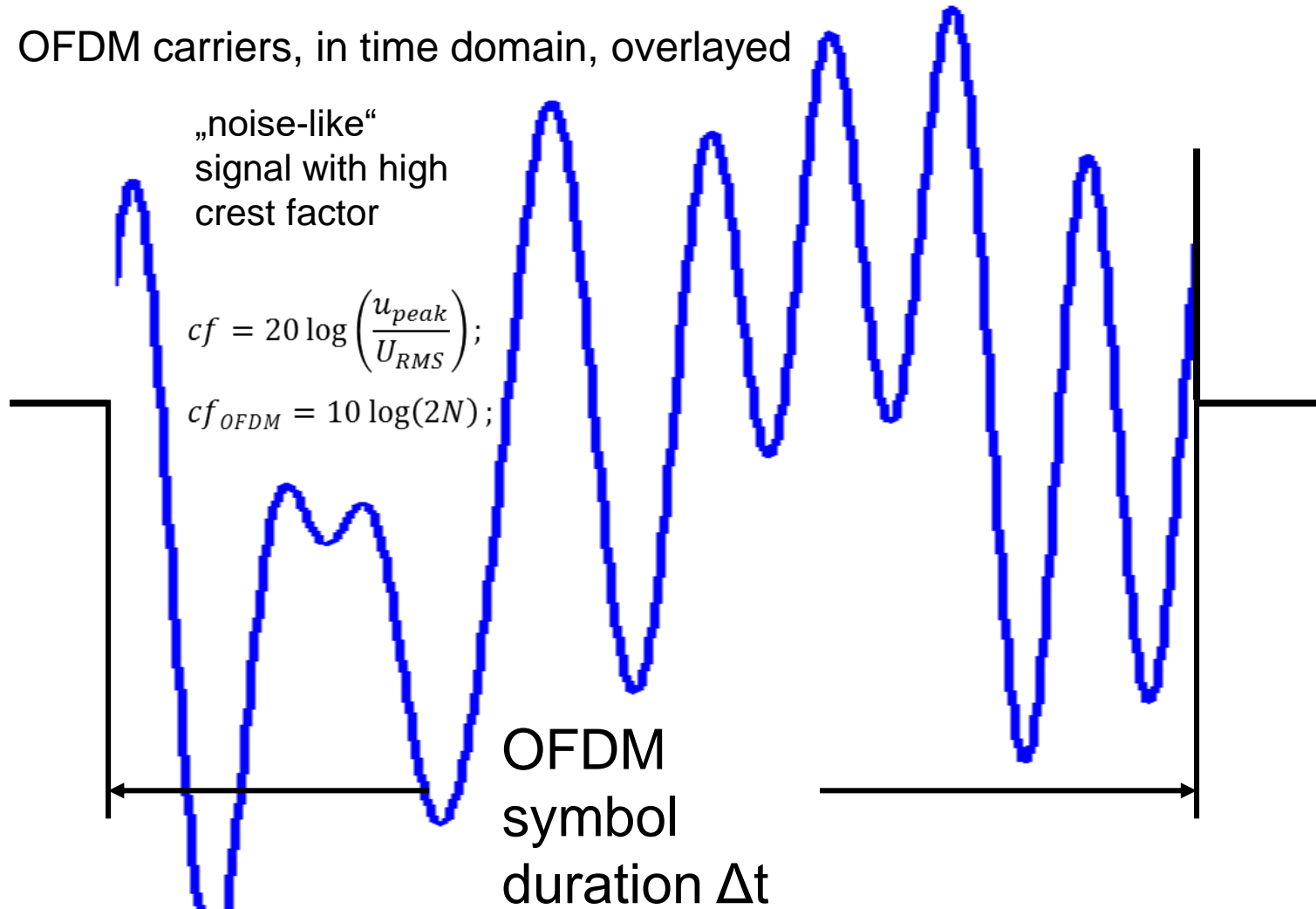

Guard Interval / CP before and behind of the Symbol

DOCSIS 3.1

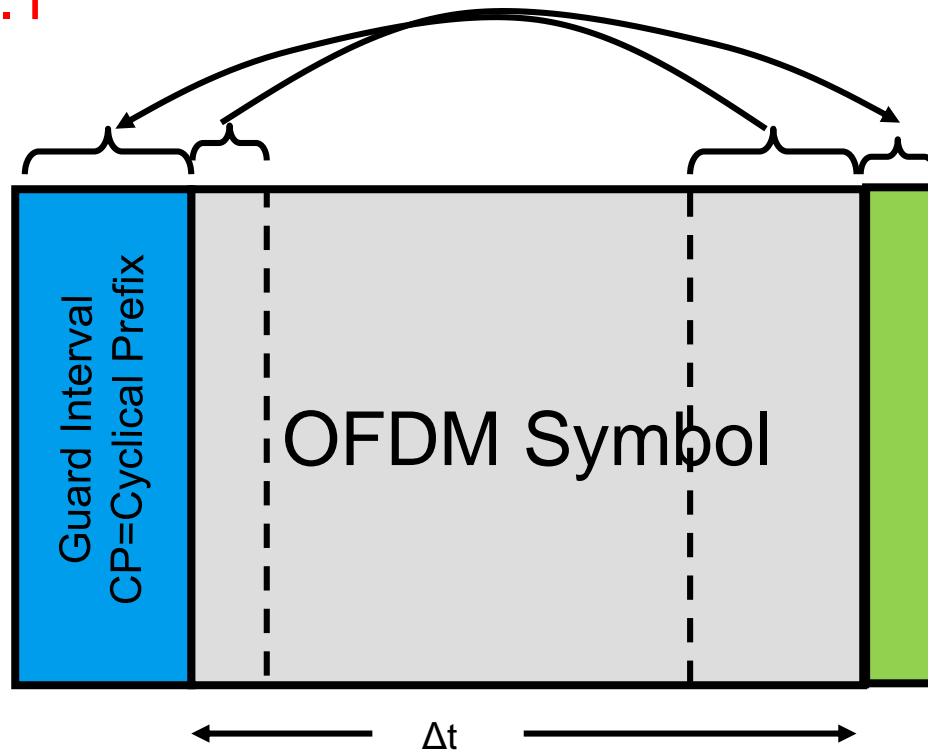

(... DOCSIS3.1 symbol duration ... 20 or 40 μ s ... OFDM, 1...5 μ s guard)



Guard Interval & Windowing

DOCSIS 3.1

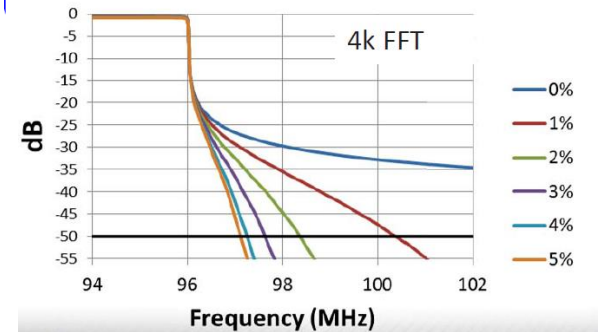
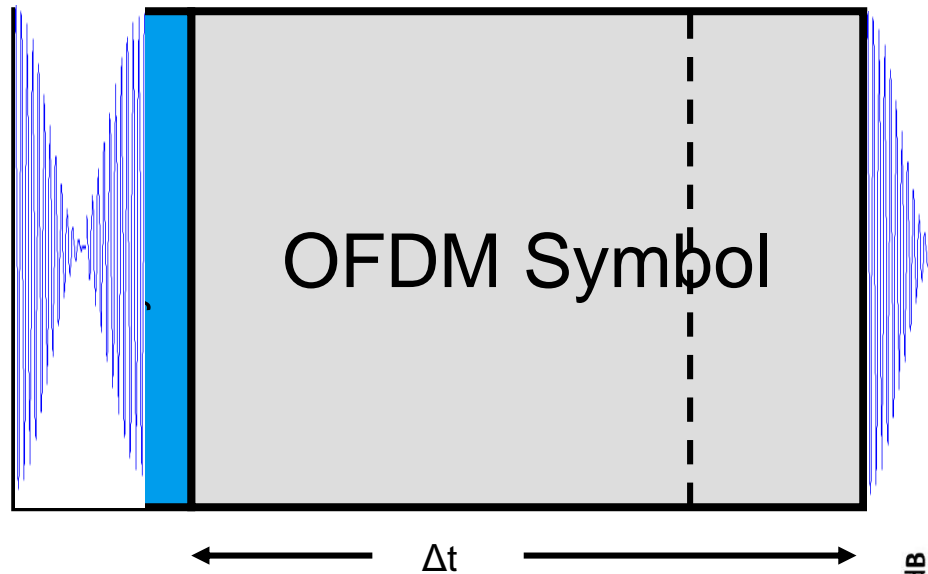

Forward Error Correction (FEC)

Forward Error Correction FEC



Transmission Channel – Channel Capacity

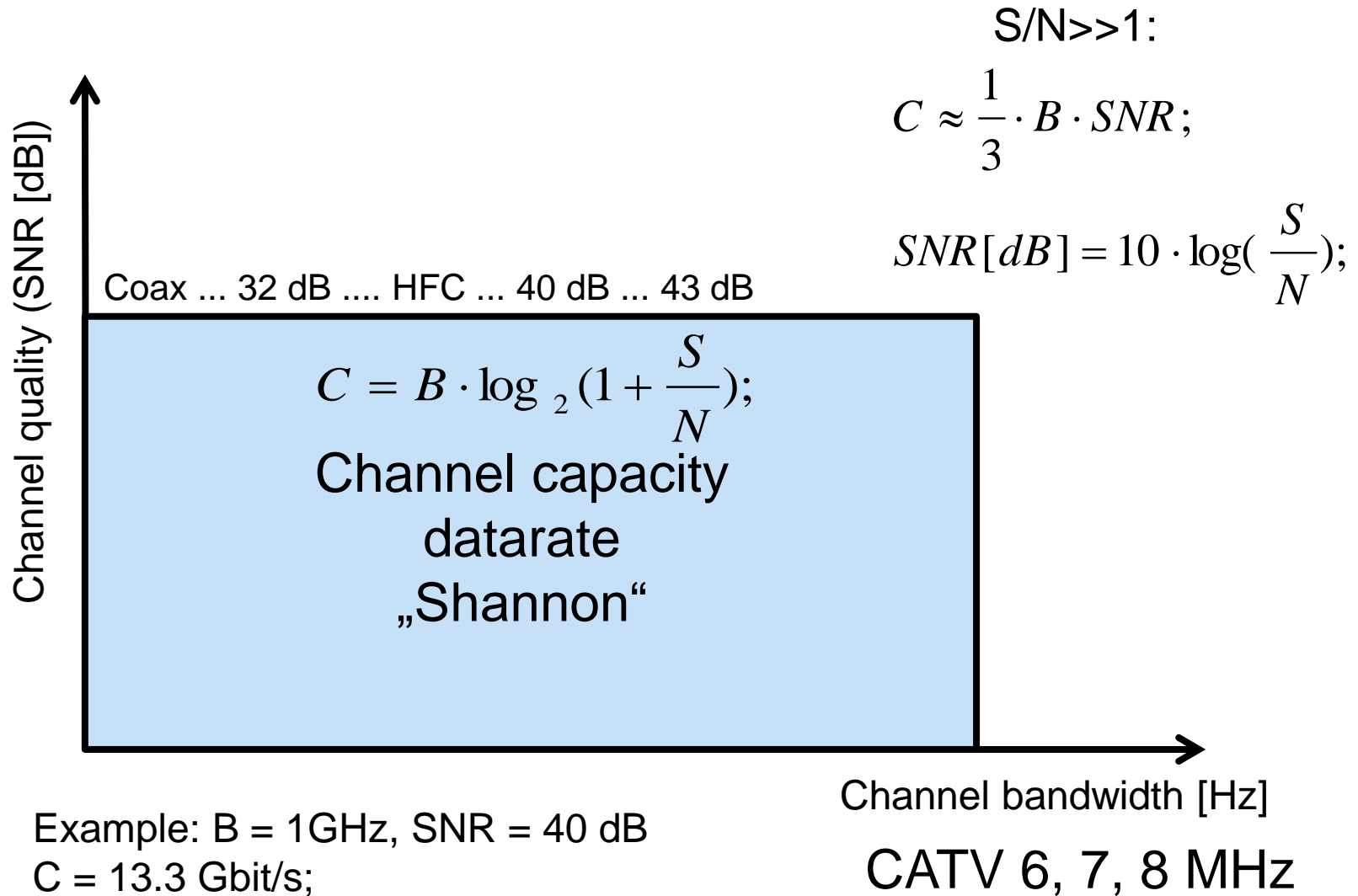

Channel coding

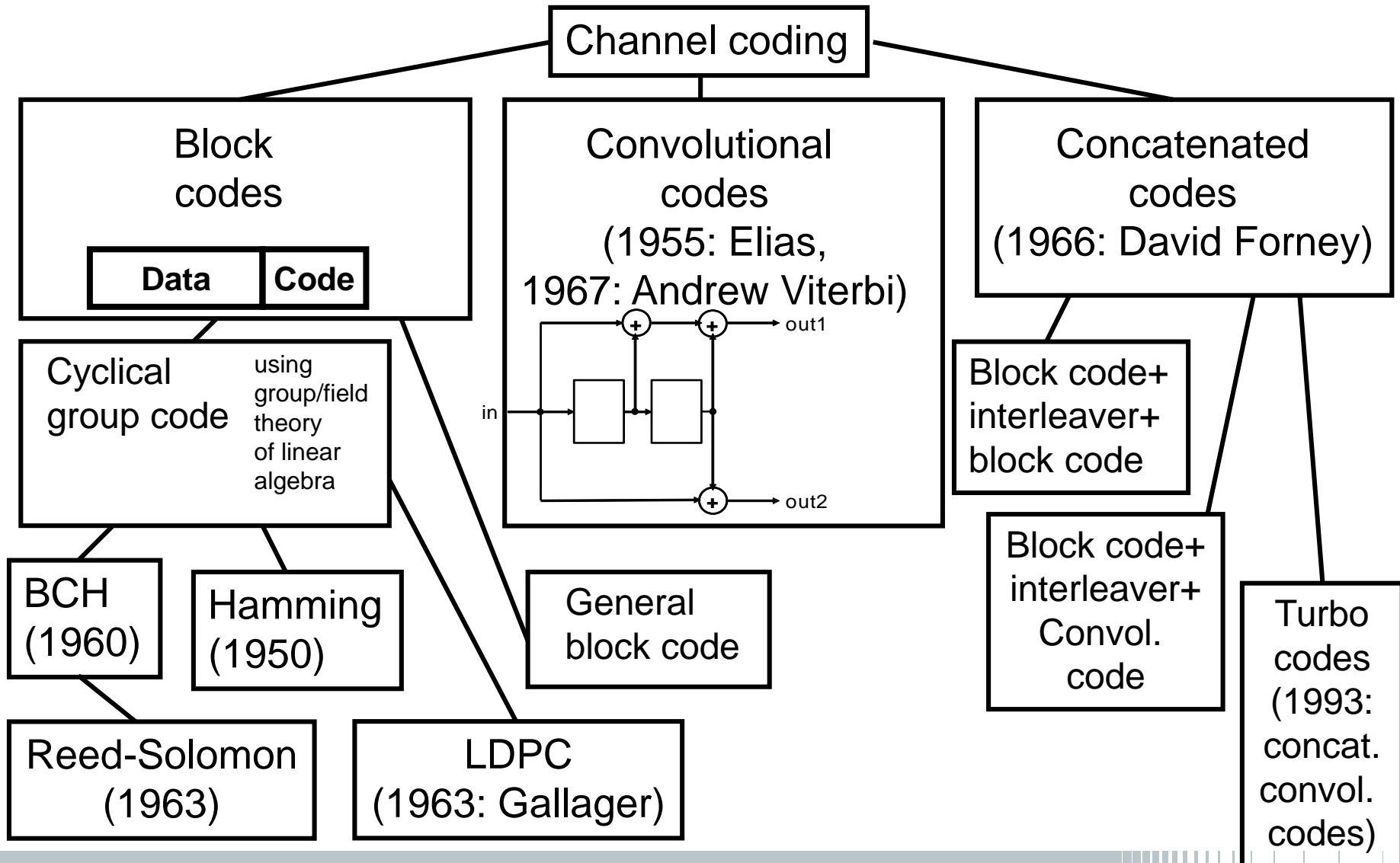

Block Code

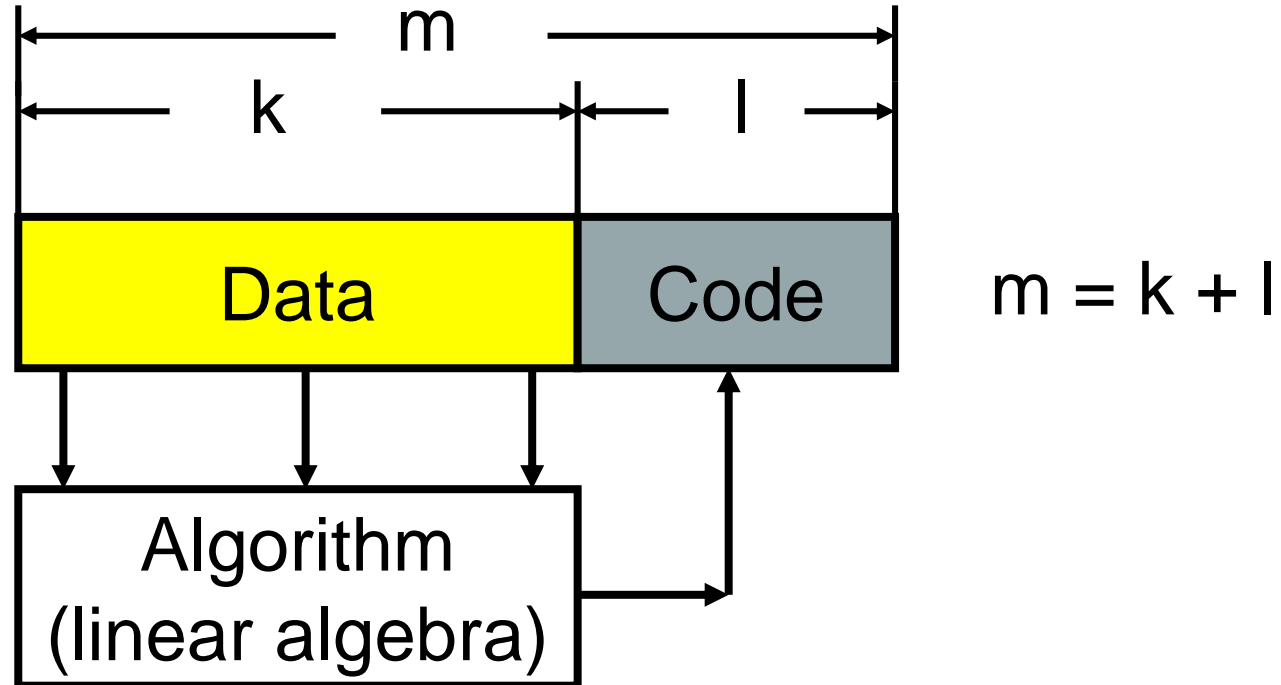

Example: DVB Reed-Solomon code:
 $k = 188$ byte, $l = 16$ byte, $m = 204$ byte

Convolutional Coding

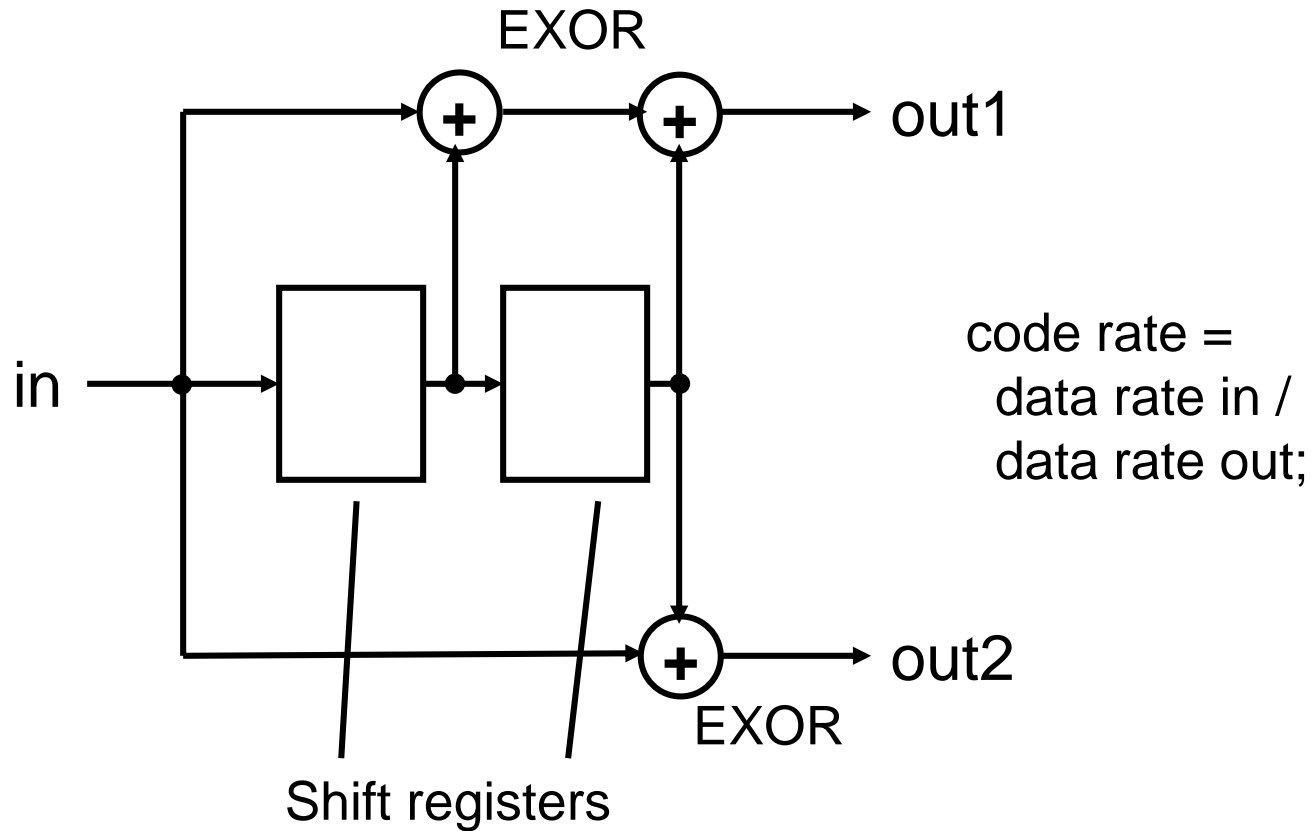

Example: GSM, UMTS, DVB inner coder



Typical FEC Structure

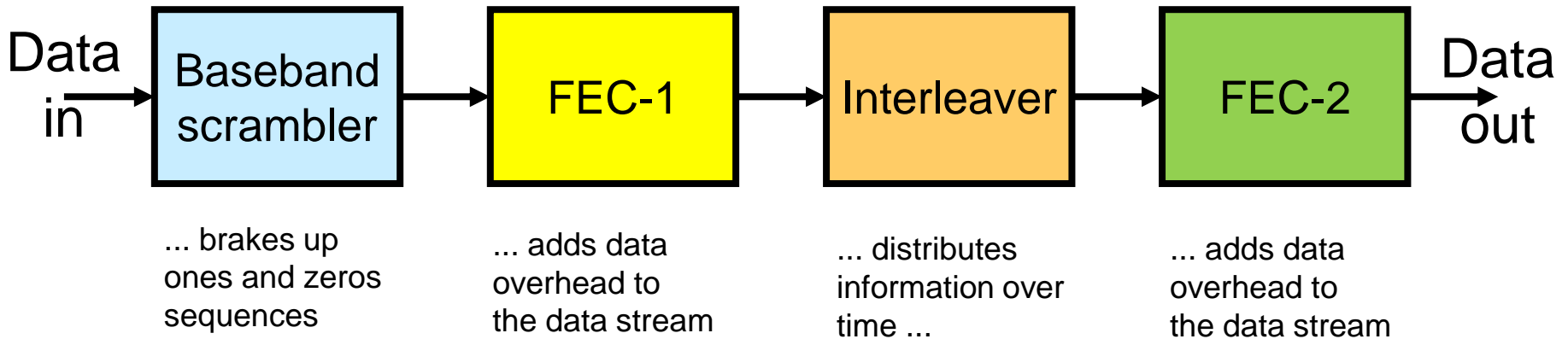
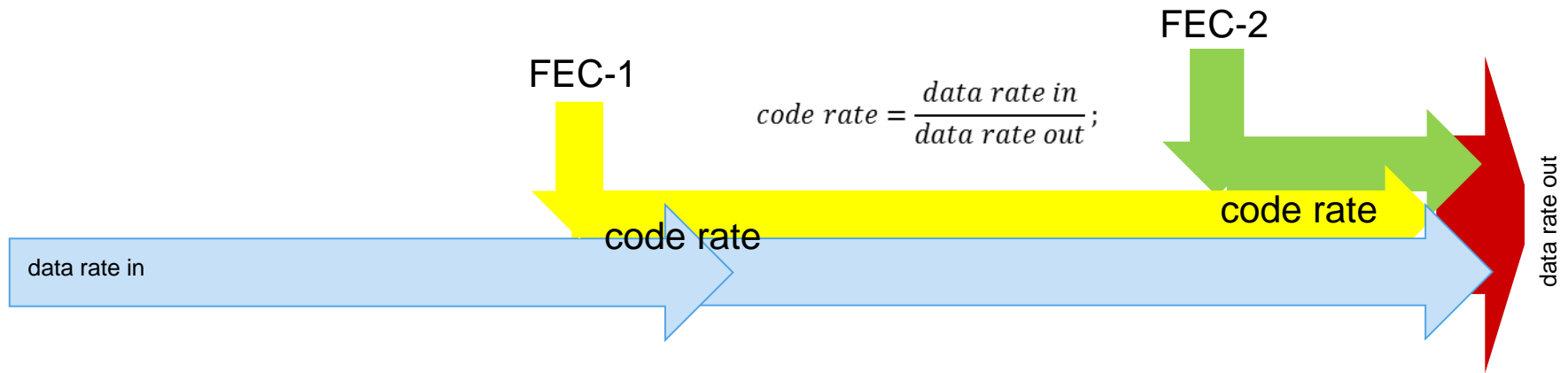

DVB-T FEC Structure

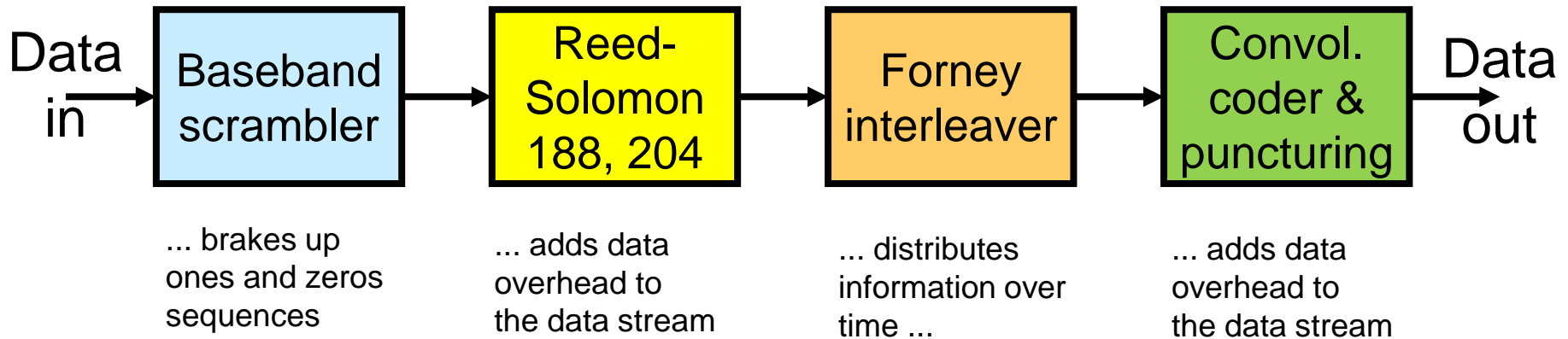
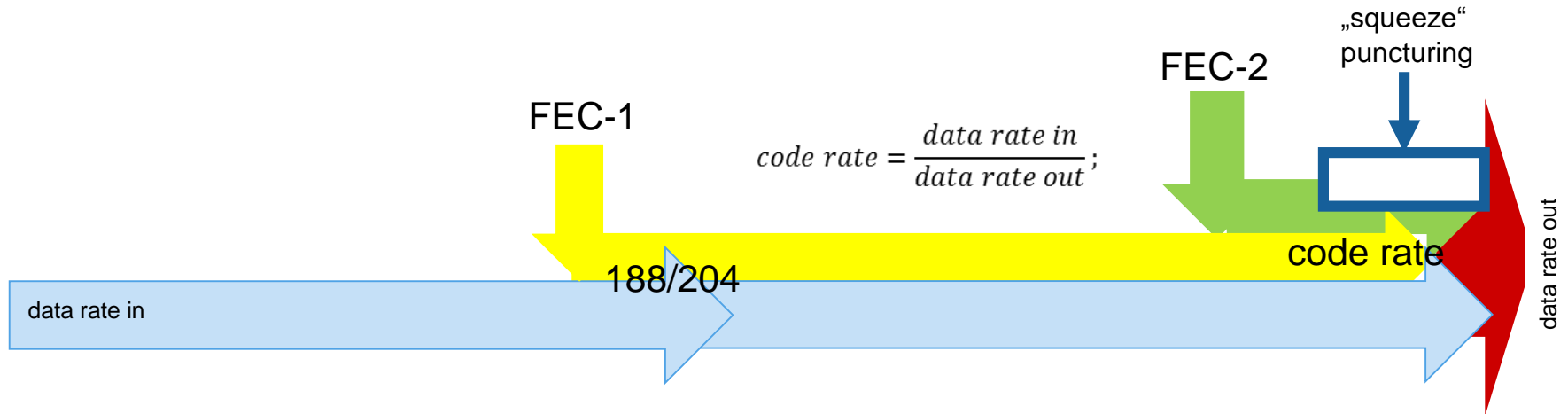

DVB-T2 & DOCSIS3.1 FEC Structure

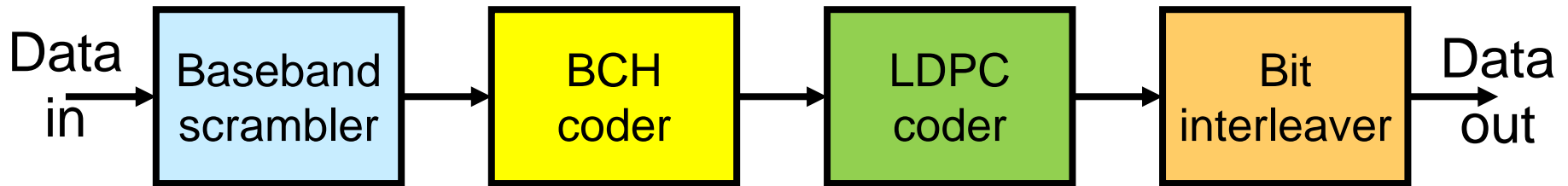
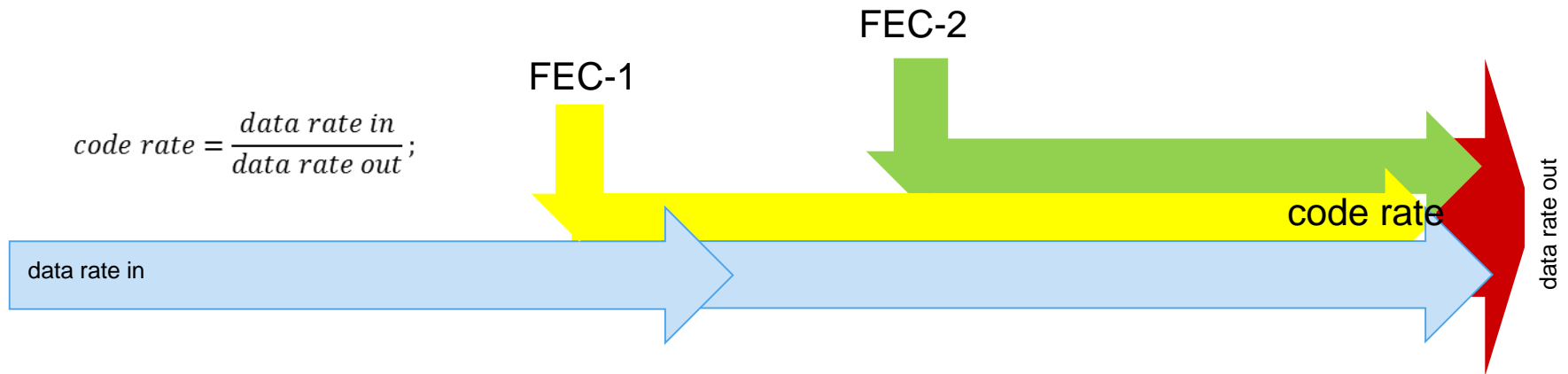

... brakes up ones and zeros sequences

... adds data overhead to the data stream

... adds data overhead to the data stream „Low Density Parity Check Coding“

... distributes information over time ...

BCH=Bose-Chaudhuri-Hocquenghem
LDPC=Low Density Parity Check Code



OFDM Subcarriers

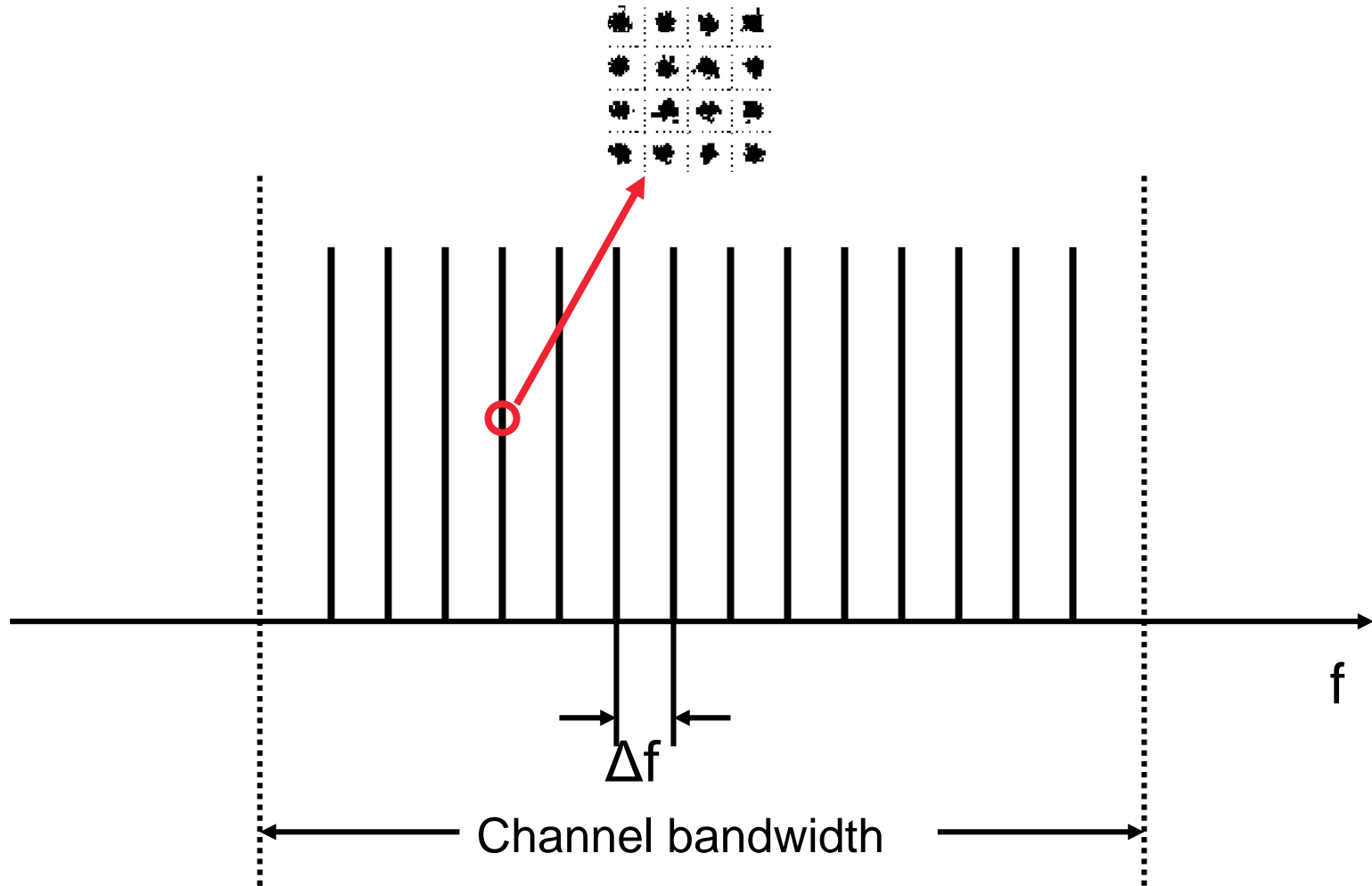

(... DOCSIS3.1 carrier distance ... 25 or 50 kHz)

Orthogonality

Orthogonality condition: $\Delta f = 1/\Delta t$

(... DOCSIS3.1 symbol duration ... 20 or 40 μs ... OFDM, 1...5 μs guard)

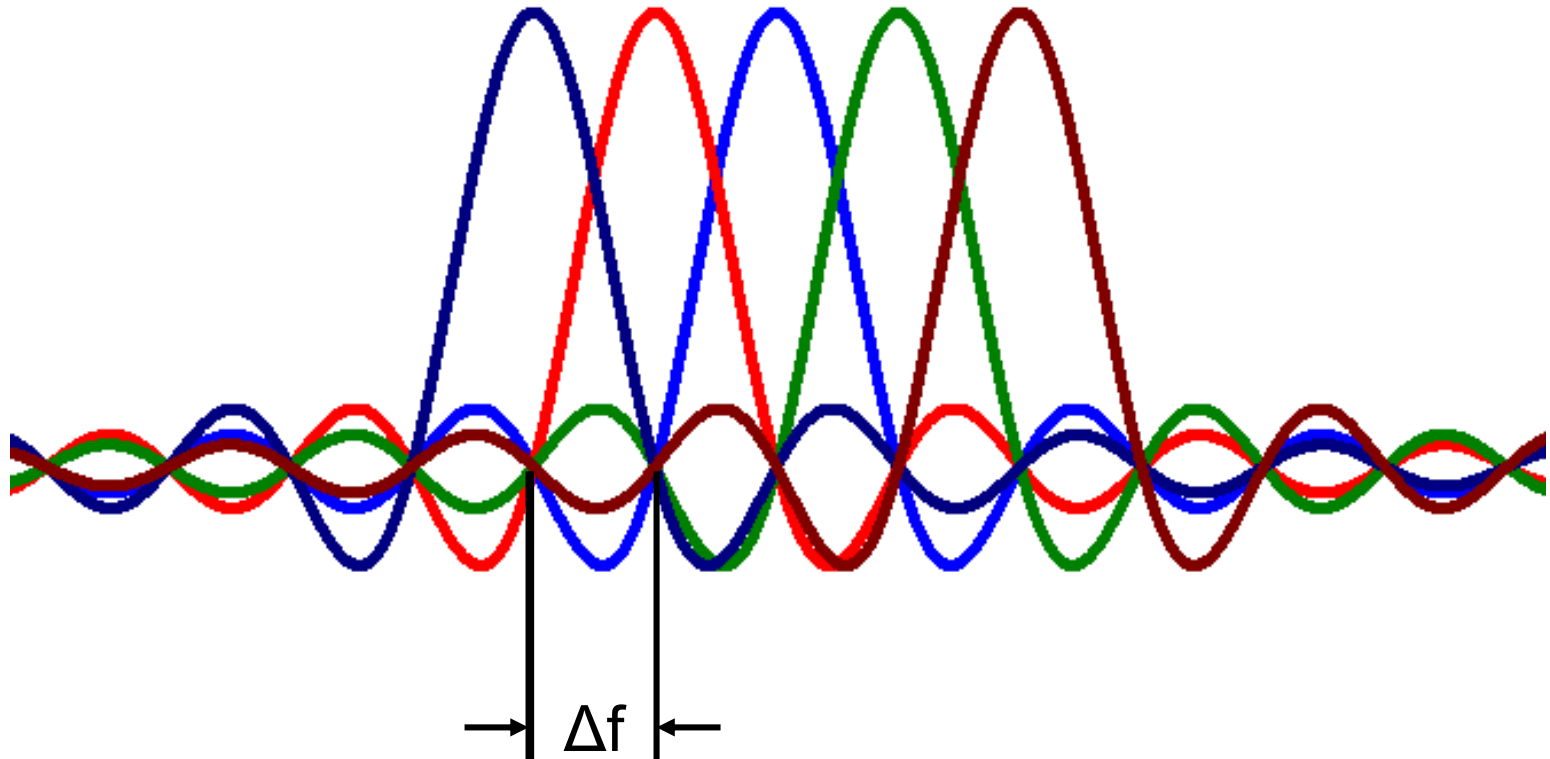

(... DOCSIS3.1 carrier distance ... 25 or 50 kHz)

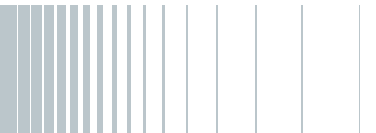

OFDM ... Pilots ... (Example: DVB-T)

TPS=
Transmission
Parameter
Signalling;
BPSK modulated;
signalling of
DVB-T transmission
parameters

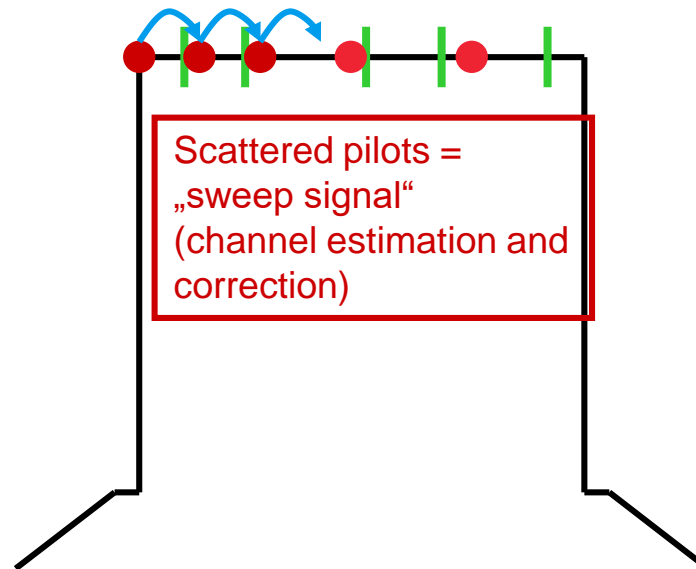

Continual Pilots,
fixed position in
spectrum and
in constellation
diagram
(AFC =
Automatic
Frequency
Control)



Rotating constellations
in the receiver in case of a
frequency deviation;
→ frequency correction (AFC)
using continual pilots

Constellations Diagram, showing Pilot Signals

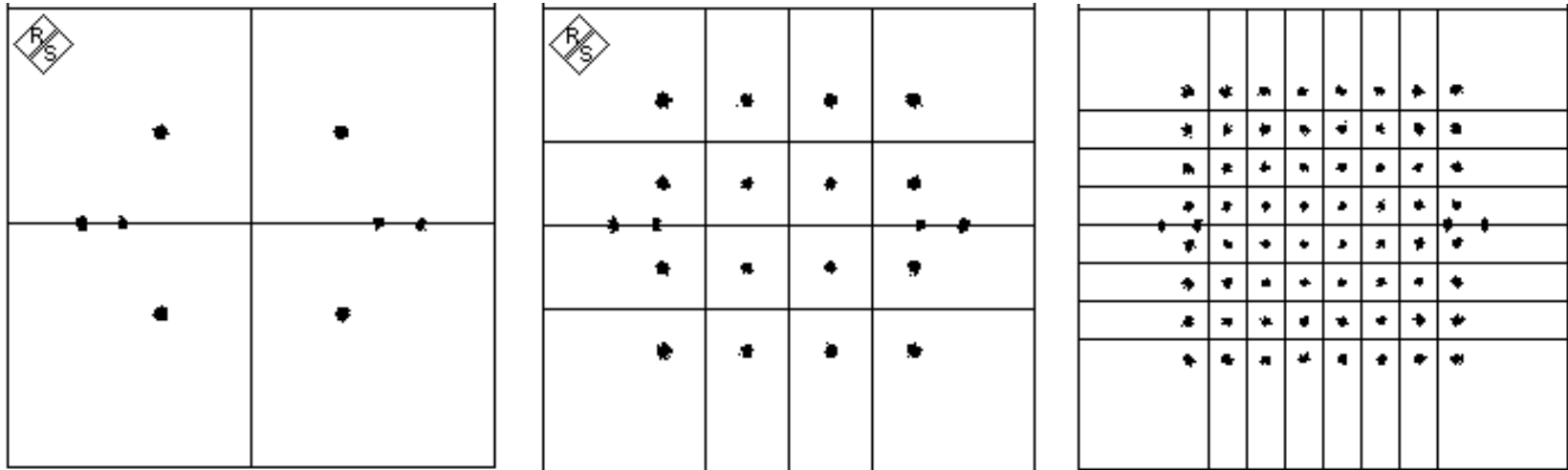

Example: DVB-T



Pilot Pattern

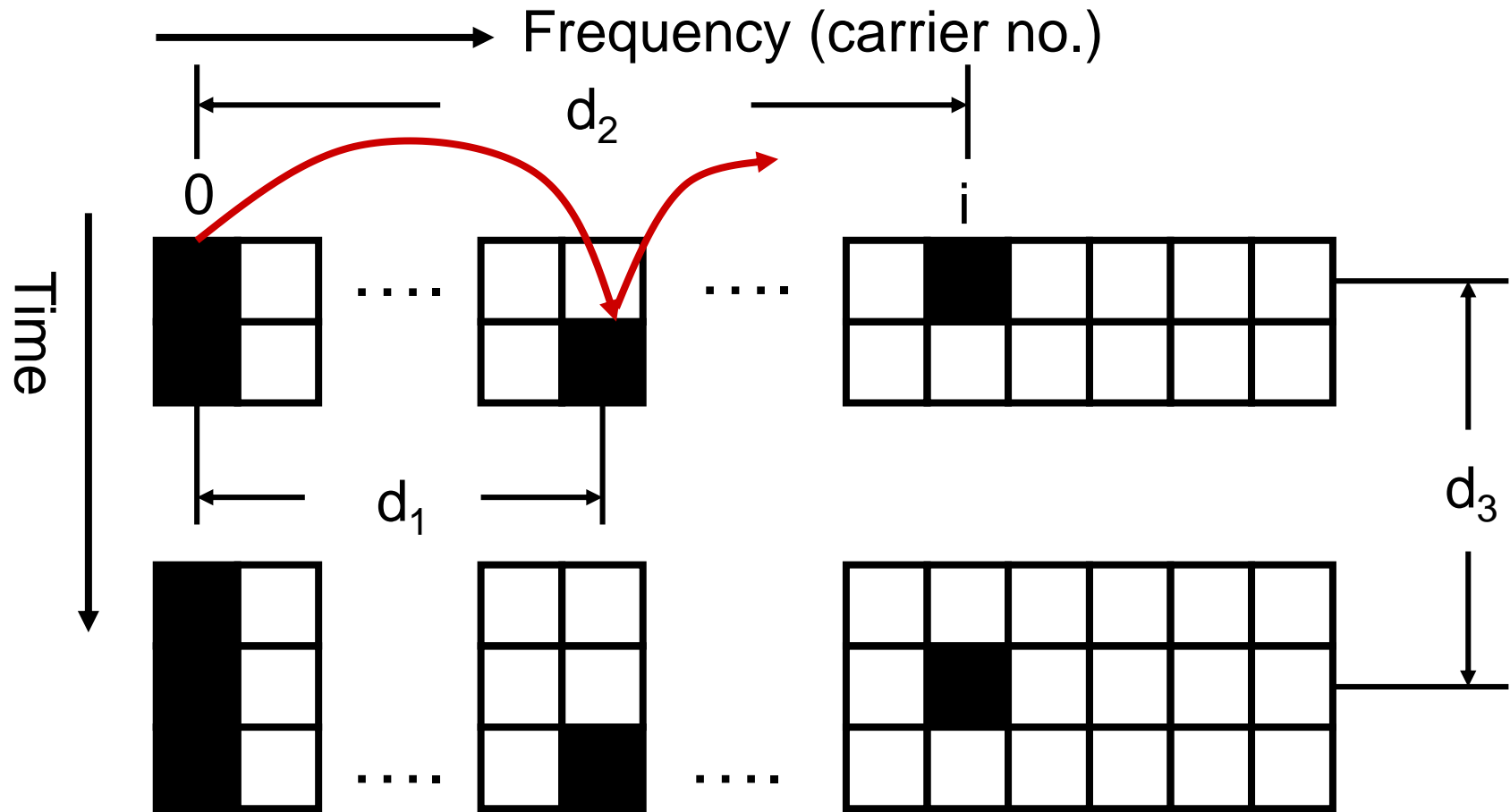

d_1 = distance between scattered pilot carrier positions
 d_2 = distance between scattered pilots in one symbol
 d_3 = symbols forming one scattered pilot sequence

Bulding OFDM Frames ... (1)

Modulated OFDM carrier signals in time domain,
discrete carriers shown ...

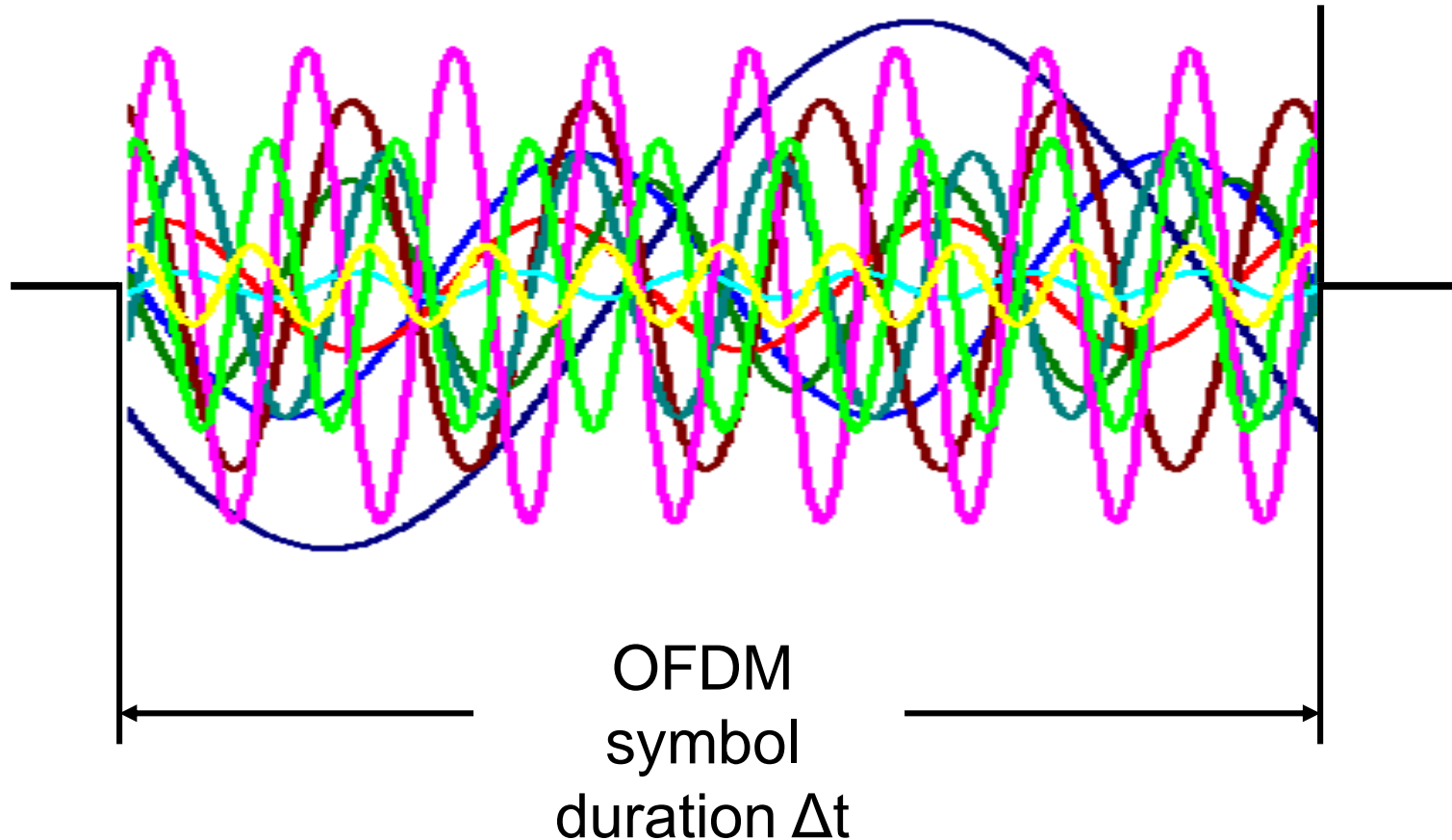

(... DOCSIS3.1 symbol duration ... 20 or 40 μs ... OFDM, 1...5 μs guard)

Building OFDM Frames ... (2)

OFDM carriers, in time domain, overlaid

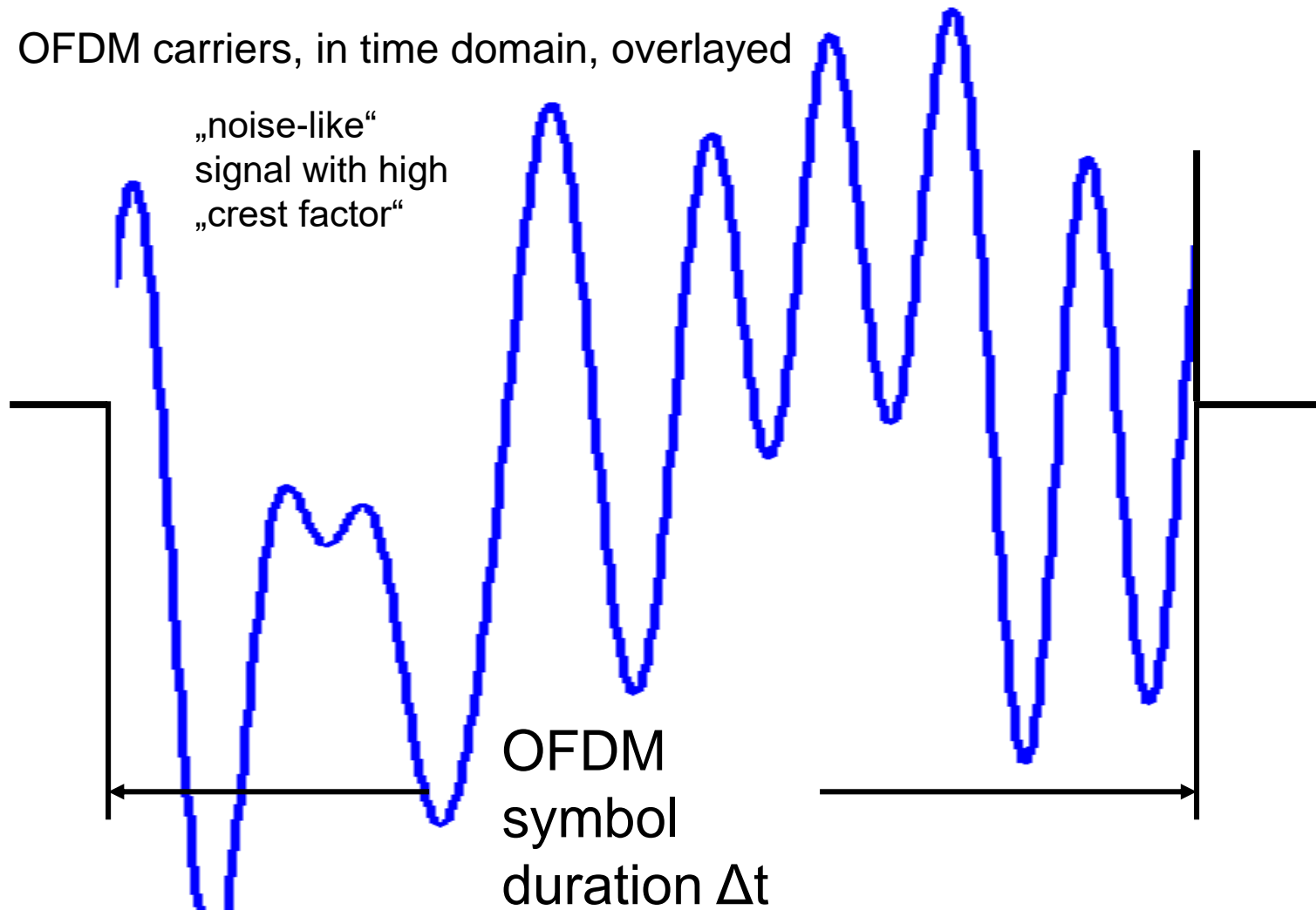

Building OFDM Frames ... (3)

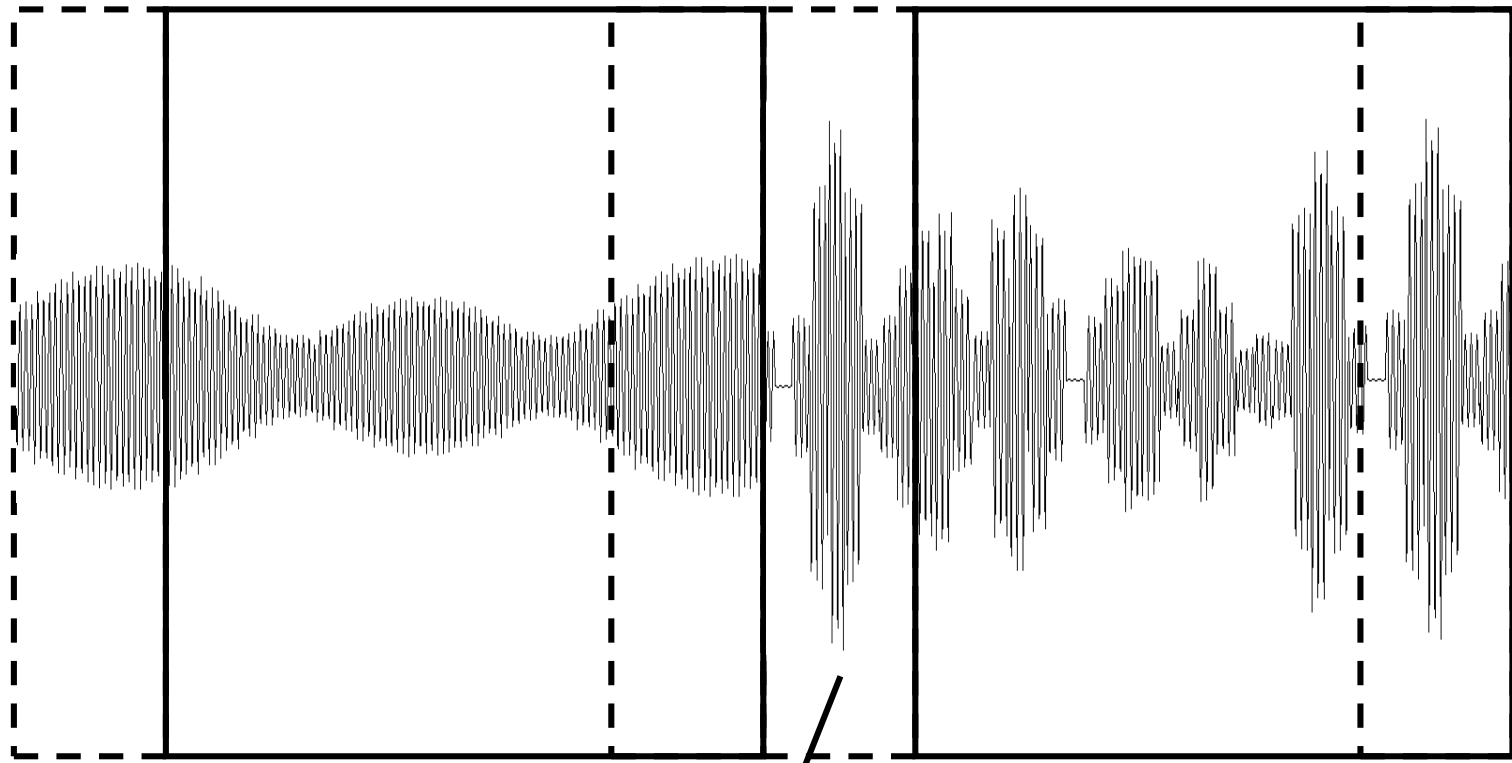

Symbol n

Symbol n+1

Guard interval
cyclical prefix (CP)

From a OFDM Symbol to a OFDM Frame (4) ...

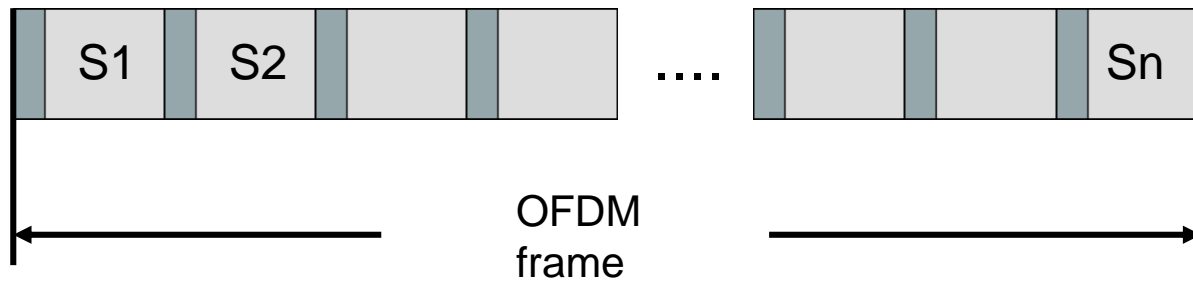

S1 ... Sn = OFDM symbols incl. guard interval

n symbols = 1 frame

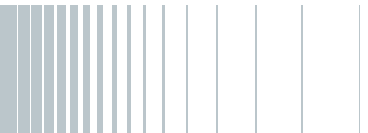

From a OFDM symbol to a OFDM Frame ... (5)

67 TPS bits, scattered pilots ...

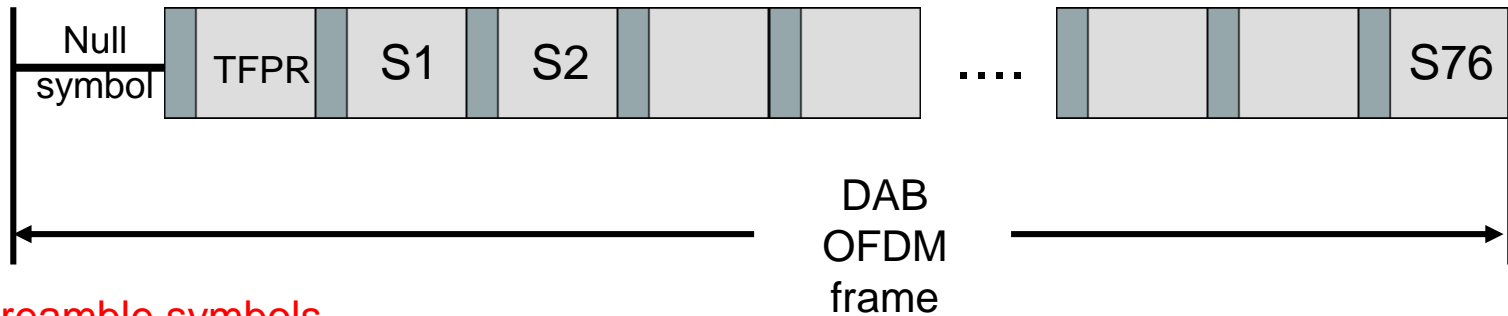
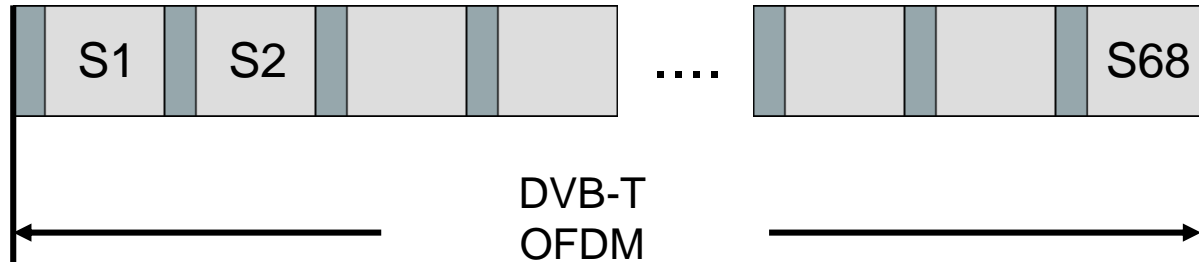

Preamble symbols

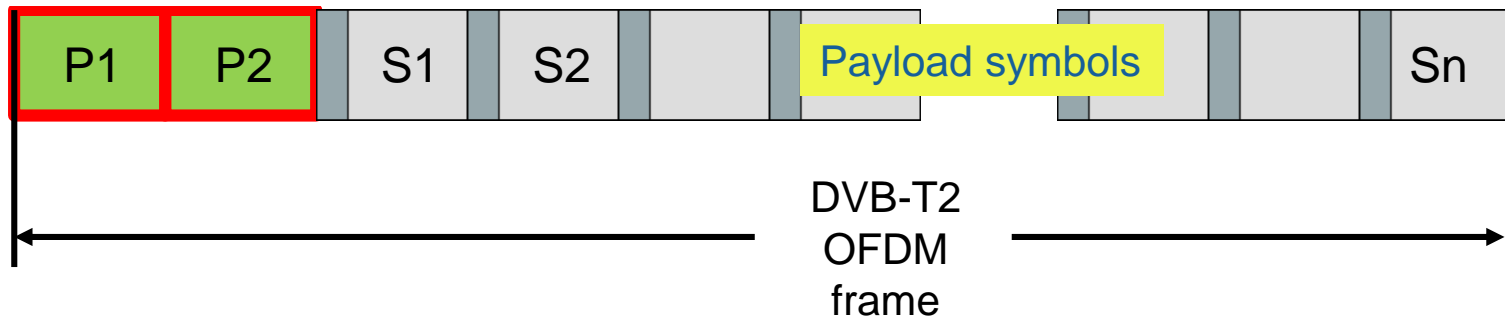

OFDM in Time and Frequency Domain (6)

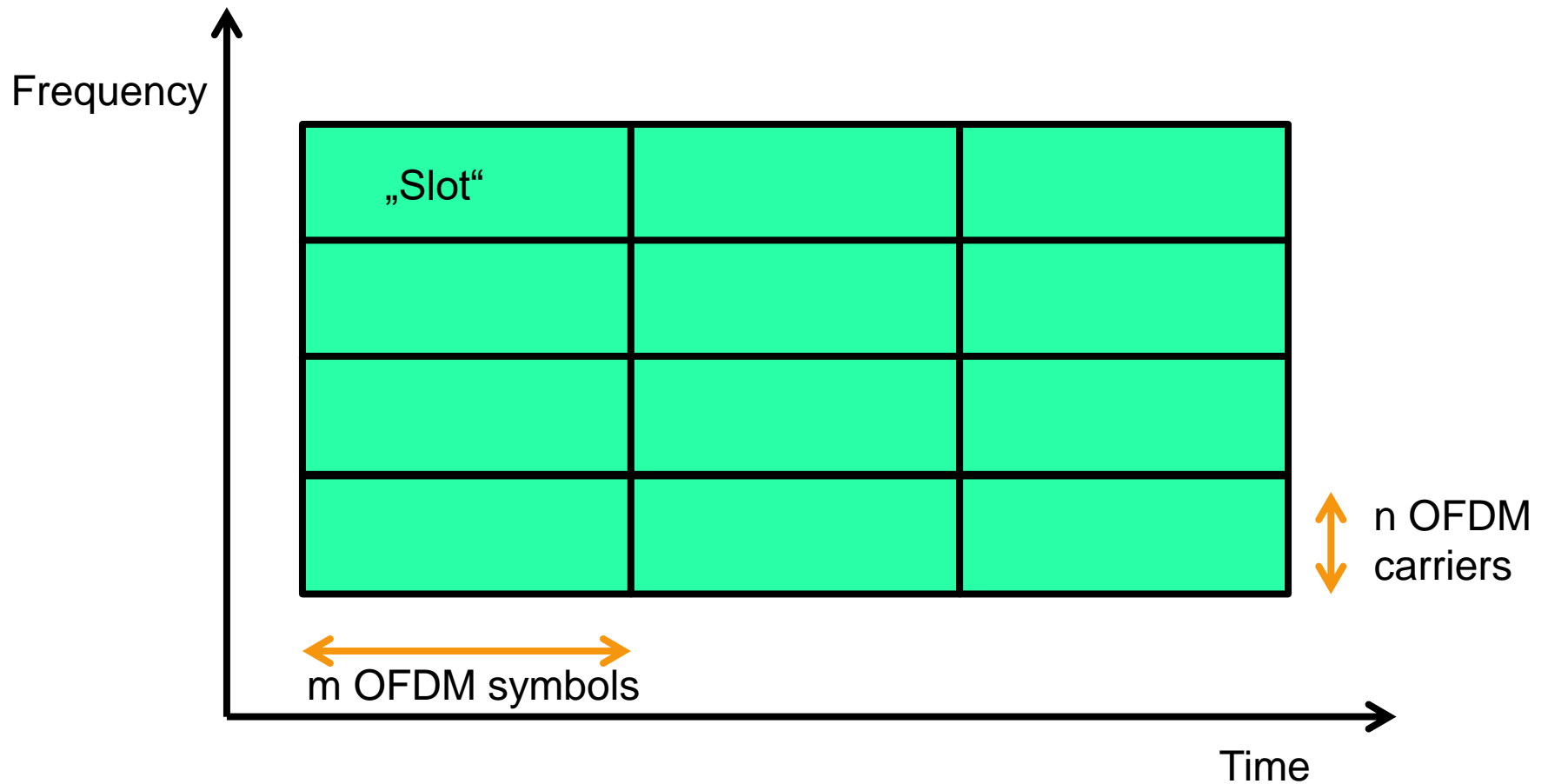

DOCSIS 3.1 Upstream

DOCSIS3.1 Upstream

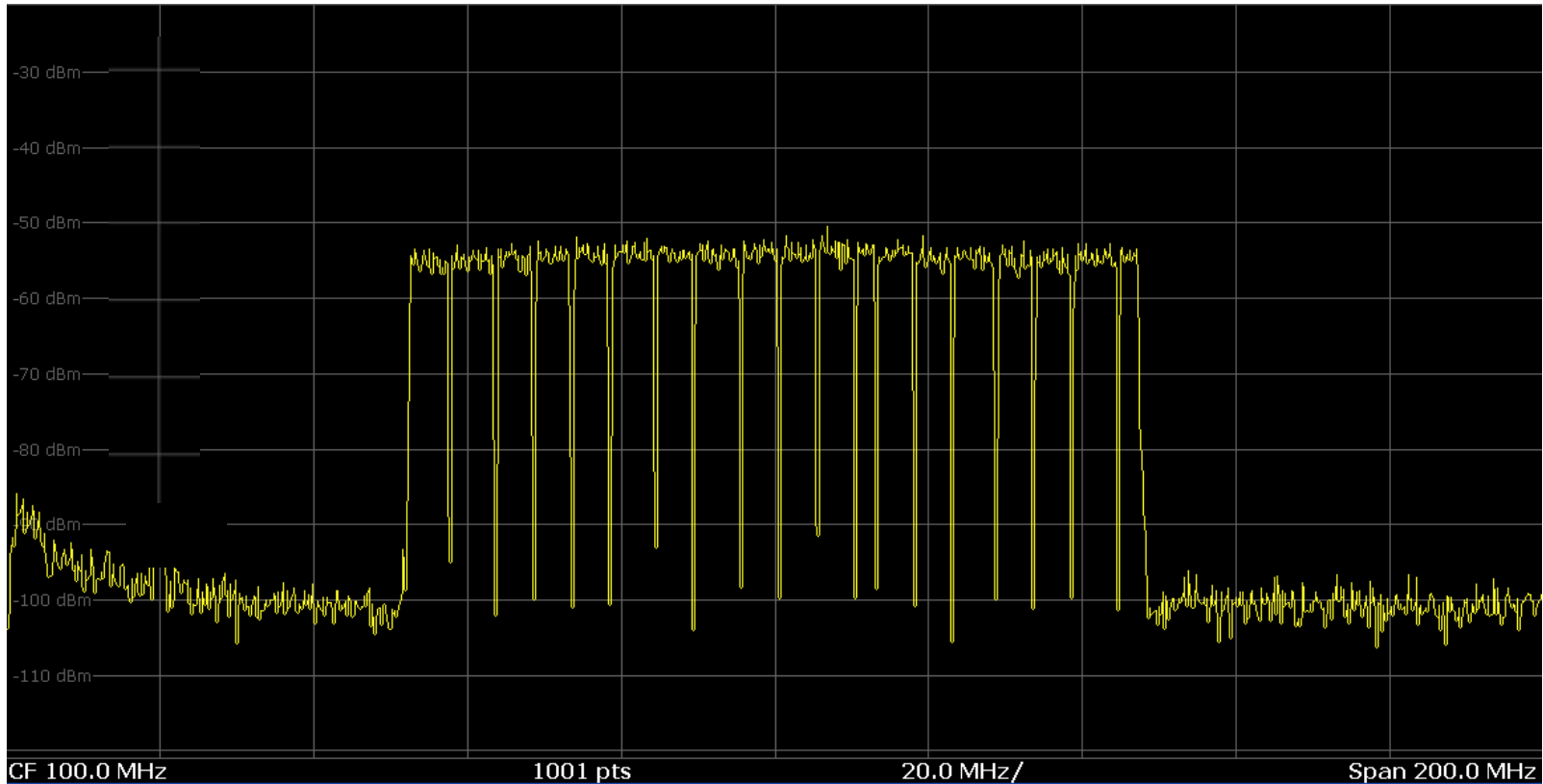

From DVB-C2 to DOCSIS 3.1

DOCSIS Intro and Principle

Single Carrier Modulation Principle

Time Domain and Spectrum Domain

QAM and SNR Requirement

OFDM Basics, OFDM in CATV

DOCSIS 3.1 Physical Layer Parameters

DOCSIS 3.1 Demo Transmission

From DVB-C2 ... to ... DOCSIS 3.1

DVB-C2 based on DVB-T2

- narrow-band channel design (6, 8 MHz) with wide-band channel-bonding option
- Long interleaver design for broadcast applications
- Narrow OFDM subcarrier distance 1.7/2.2 kHz (4K mode in 6, 8 MHz)
- Only downstream, no upstream defined

DOCSIS 3.1 design

- wideband-band channel design (192 MHz) with narrow band option (... 24 MHz)
- Optimized for short response time ... 1 ms
- Wide OFDM subcarrier distance 25/50 kHz (4K / 8K mode in 192 MHz)
- Downstream and upstream



DOCSIS 3.1 Downstream, Upstream

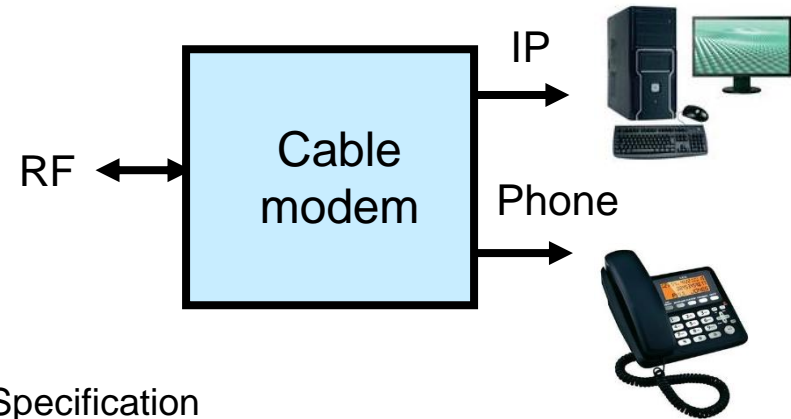
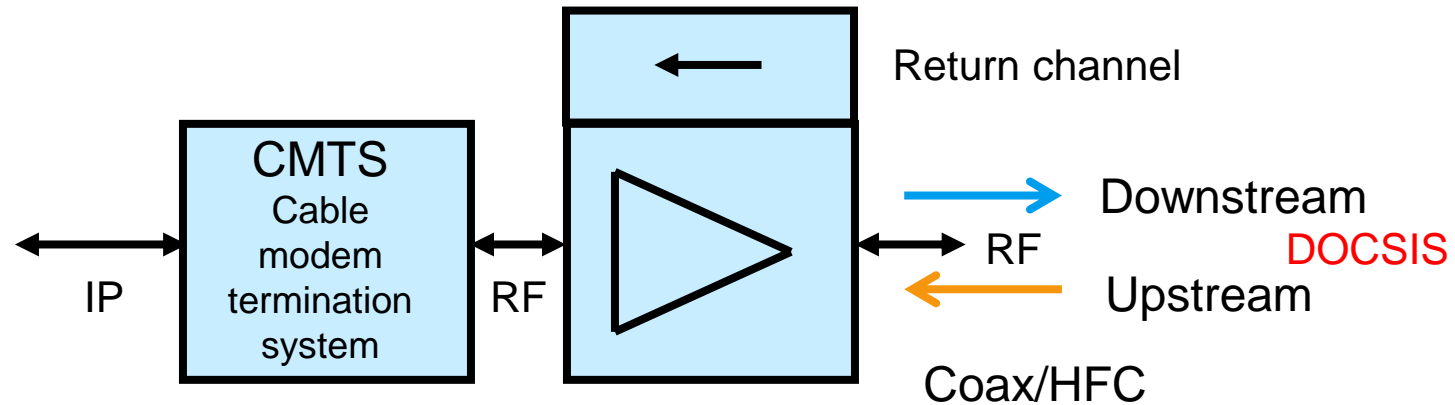

DOCSIS – Data-over-Cable Service Interface Specification

DOCSIS 3.1 Downstream

up to 16384QAM

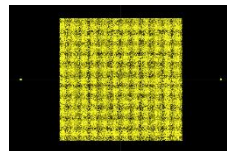

Parameter	DOCSIS 3.1	DOCSIS 3.0
Type of modulation	OFDM 4K and 8 K FFT	single carrier (J.83/B, DVB-C)
Frequency range	108 MHz to 1218 MHz (1794 MHz)	45 MHz to 1002 MHz
Channel bandwidth	up to 192 MHz	6 MHz / 8 MHz
QAM constellations	up to 4096, 8k, 16k	up to 256
Cyclic prefix length	0.9375 μ s to 5 μ s	n/a
Pilots	scattered and continuous	n/a
Forward Error Correction	BCH-LDPC	Reed-Solomon
DS capacity (bps)	8 G (10 G)	300 M (1 G)

25 kHz / 50 kHz carrier spacing
7680 / 3840 carriers in 192 MHz bandwidth



DOCSIS 3.1 Upstream

up to 4096QAM

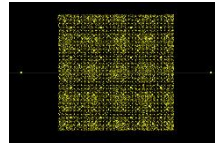

Parameter	DOCSIS 3.1	DOCSIS 3.0
Type of modulation	OFDM 2K and 4 K FFT	single carrier TDMA, S-CDMA
Frequency range	5 MHz to 204 MHz	5 MHz to 85 MHz
Channel bandwidth	up to 96 MHz	up to 6.4 MHz
QAM constellations	up to 4096	QPSK to 64
Cyclic prefix length	0.9375 μ s to 6.25 μ s	n/a
Pilots	complimentary and continuous	n/a
Forward Error Correction	LDPC	Reed-Solomon
DS capacity (bps)	400 M (1 G to 2.5 G)	100 M (300 M)

25 kHz / 50 kHz carrier spacing
3840 / 1920 carriers in 96 MHz bandwidth



DOCSIS 3.1 Frequency Plan

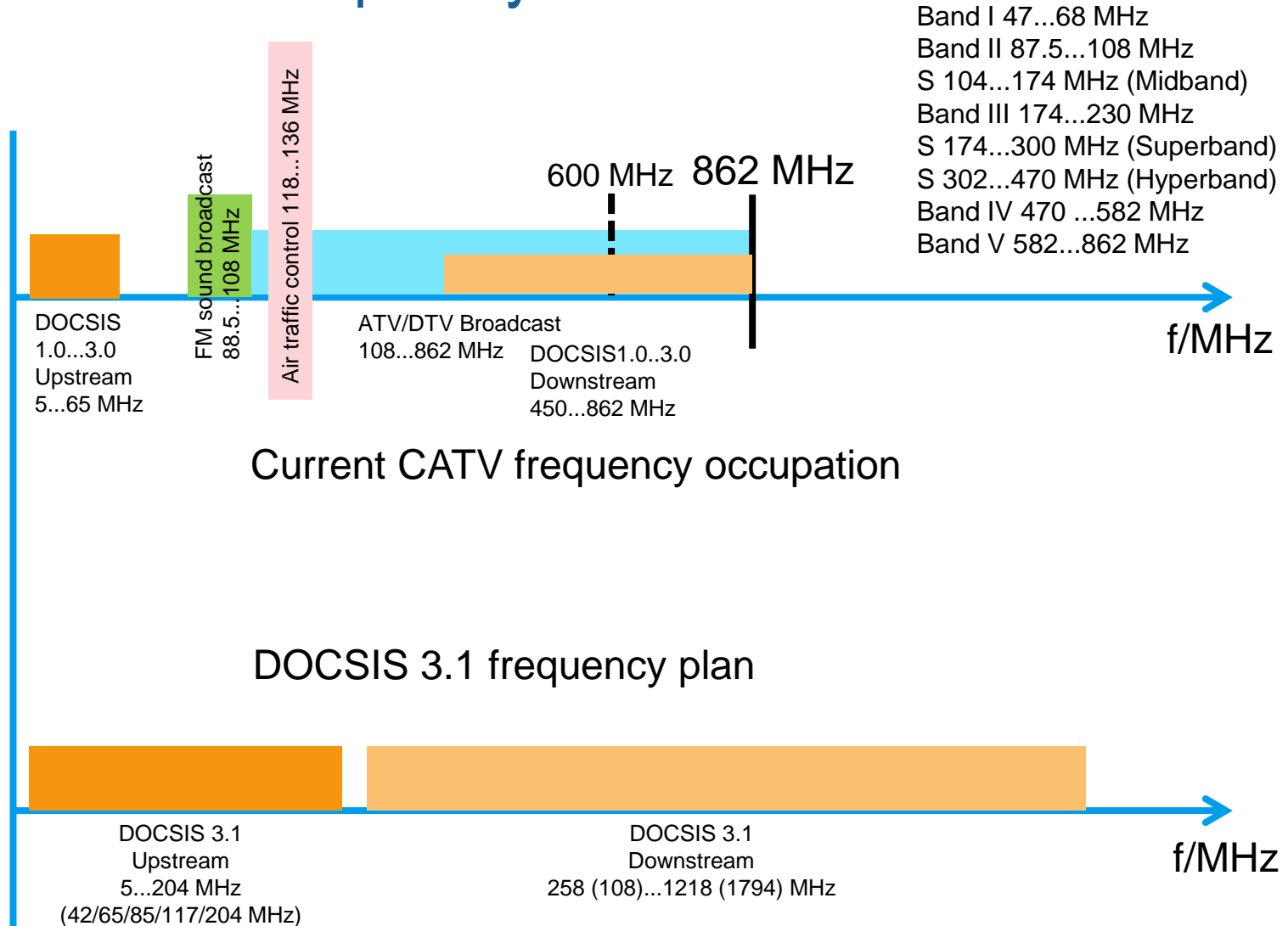

DOCSIS 3.1 Channel Occupation

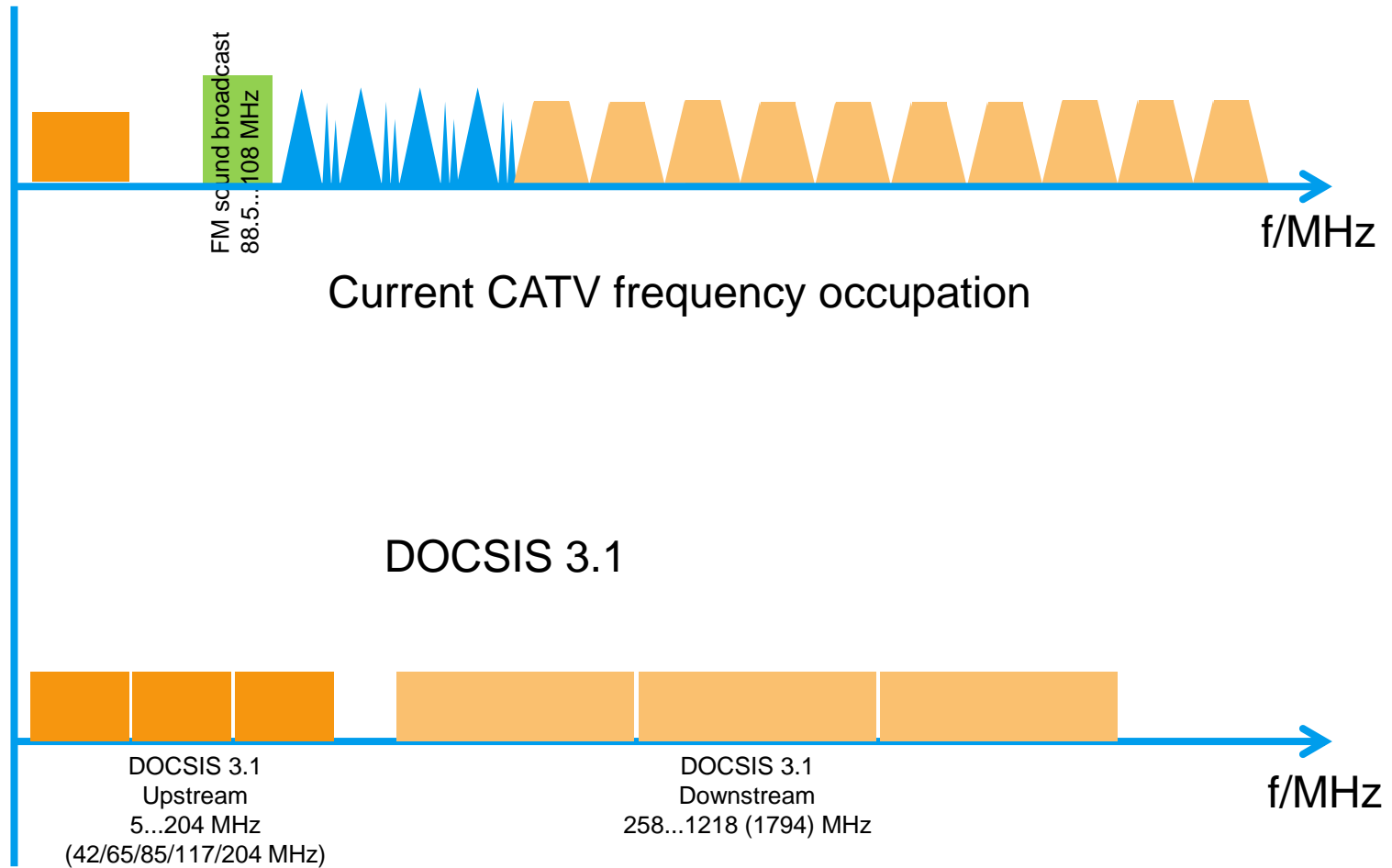

DOCSIS 3.1 Upstream Structure

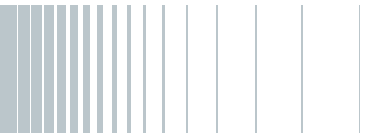
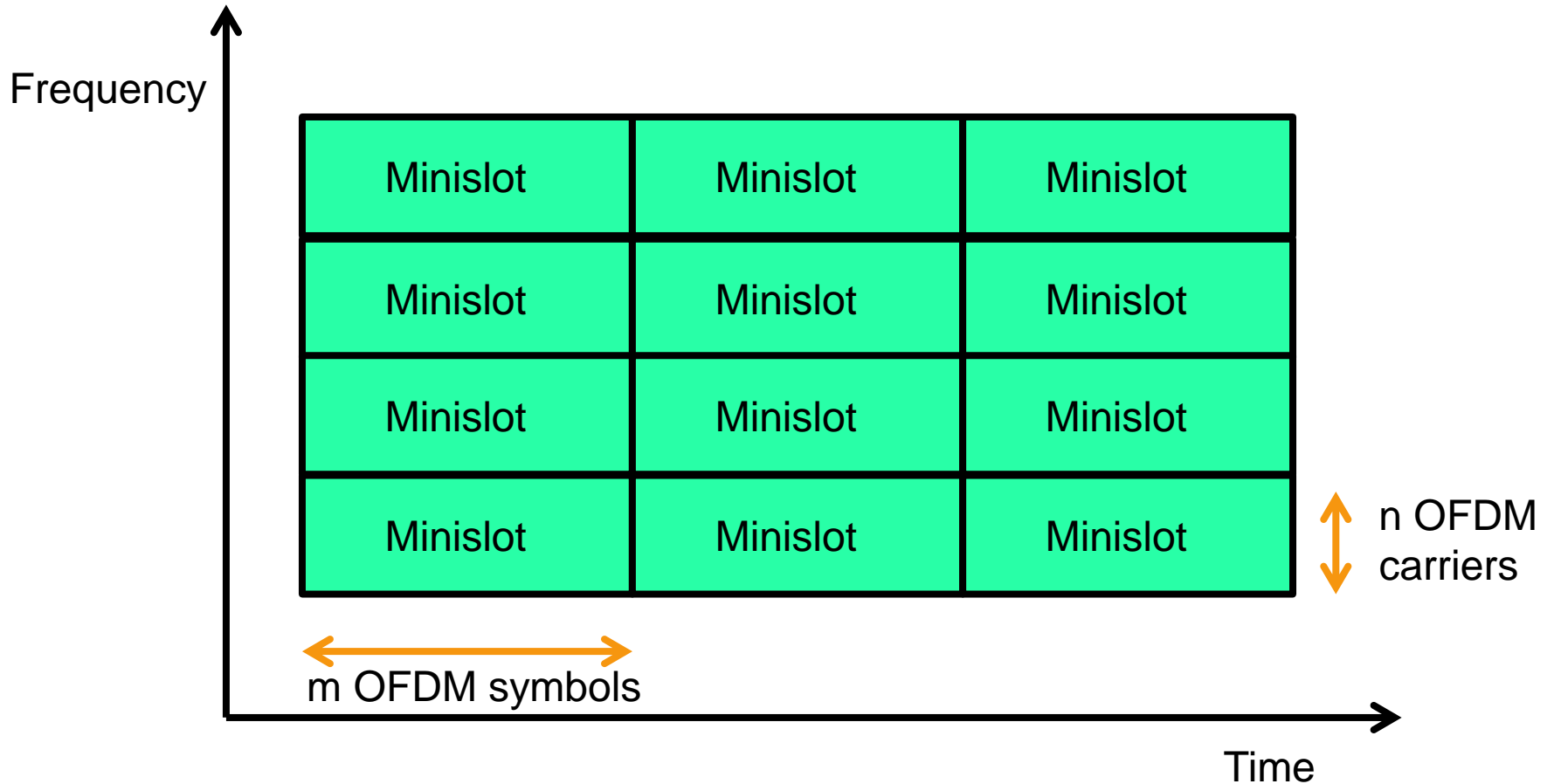

DOCSIS 3.1 Downstream Spectrum

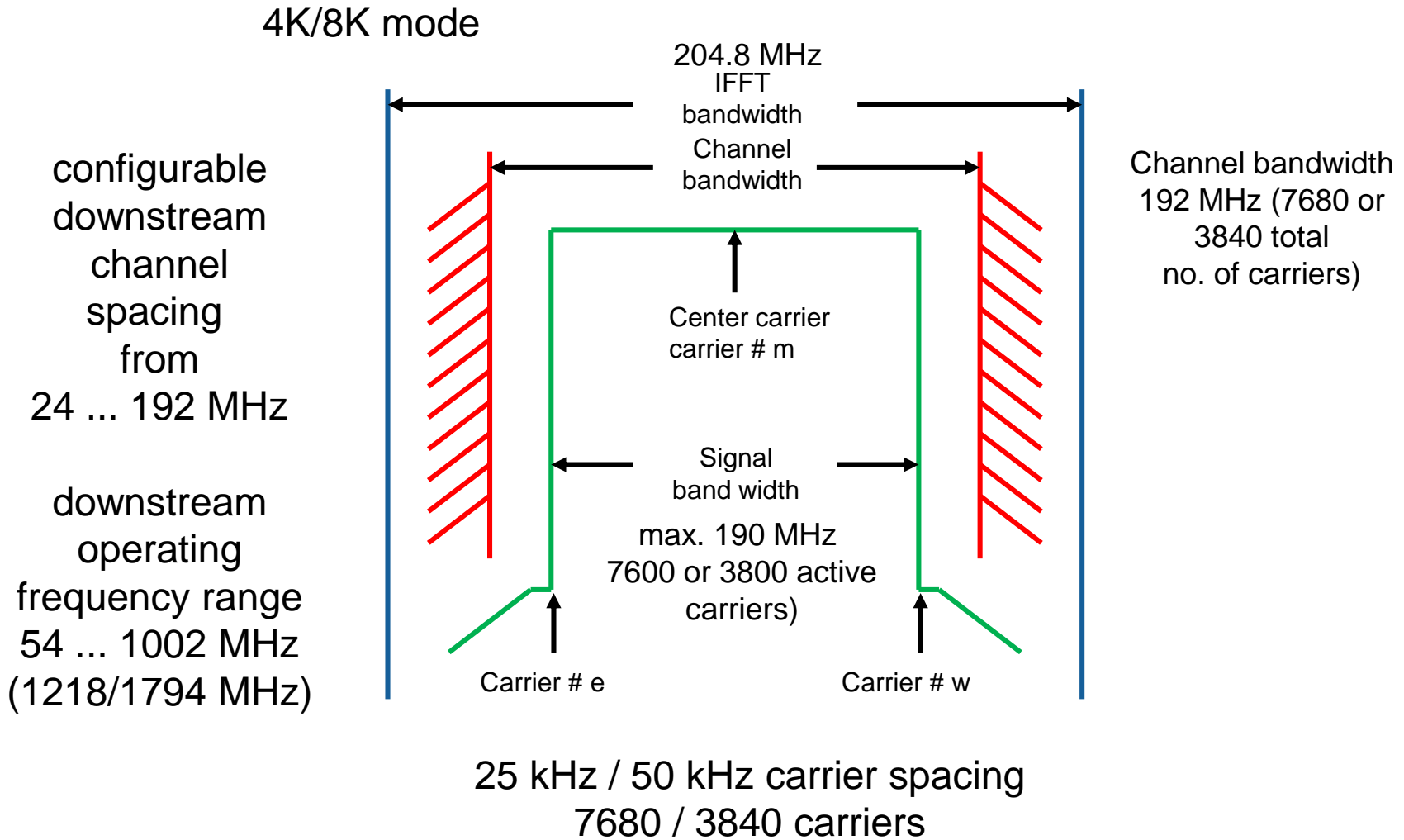

(... DOCSIS3.1 symbol duration ... 20 or 40 μ s ... OFDM, 1...5 μ s guard)



DOCSIS 3.1 Upstream Spectrum

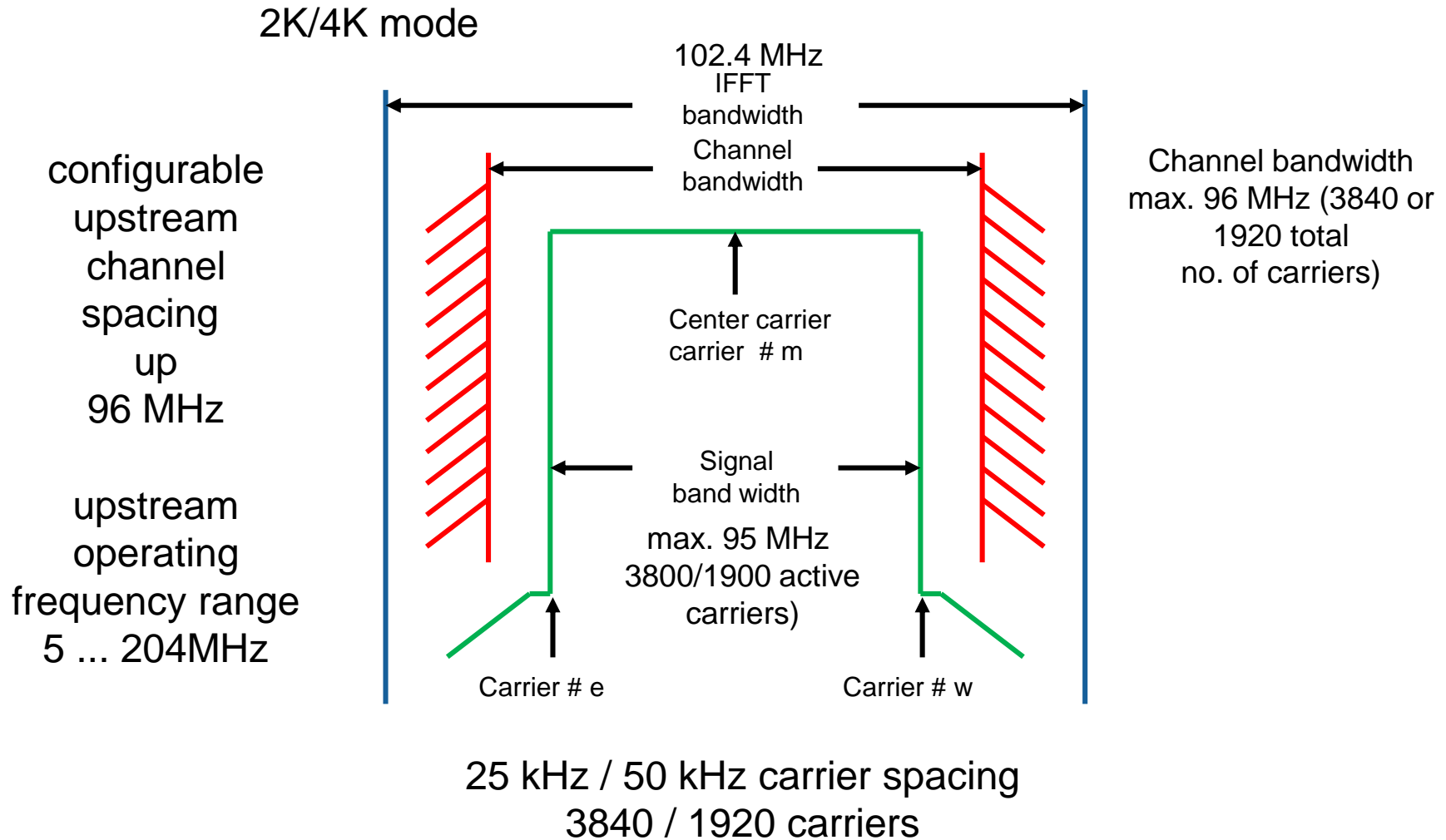

(... DOCSIS3.1 symbol duration ... 20 or 40 μ s ... OFDM, 1...5 μ s guard)

Single Carrier Spectrum versus OFDM Spectrum

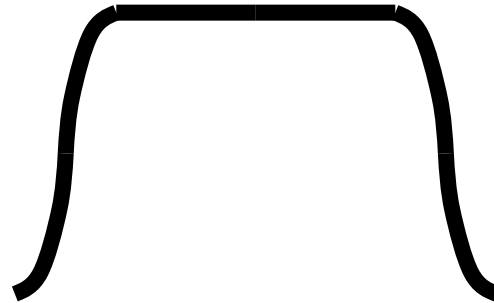

Typical single carrier spectrum
with roll-off

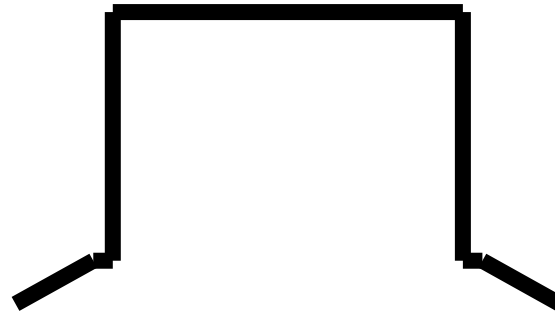

Typical OFDM spectrum



Single Carrier Spectrum versus OFDM Spectrum

Typical single carrier spectrum
with roll-off

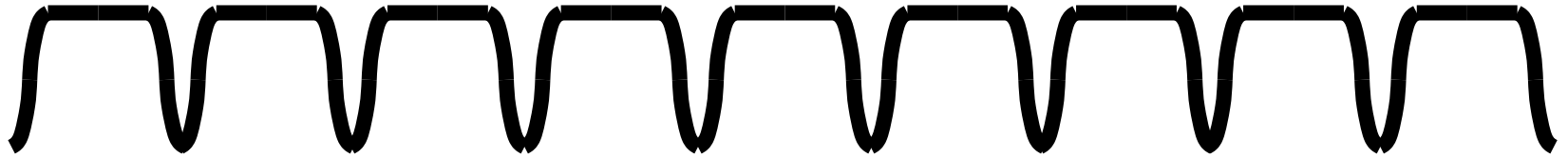

Wide-band DOCSIS OFDM „channel“

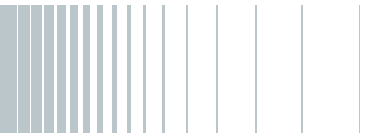
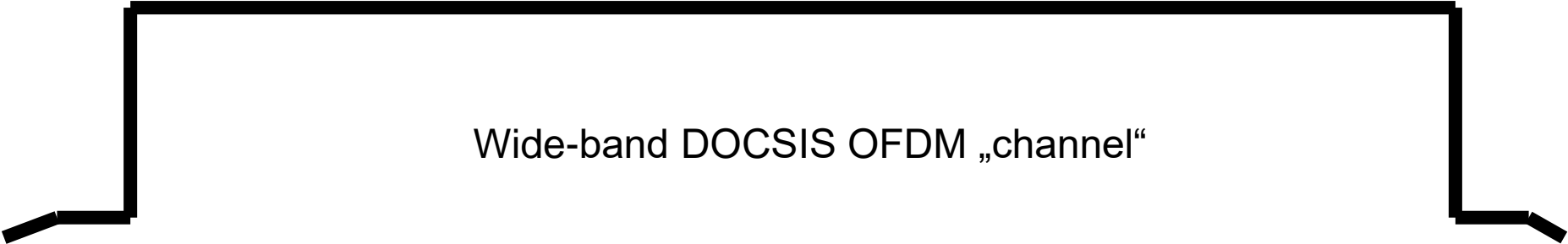

Pilots in DOCSIS 3.1

DOCSIS 3.1 spectrum contains

- data subcarriers, different modulation parameters due to profiles
- continuous pilots (fix position, for AFC)
- scattered pilots (var. position for measurement purposes)
- PLC subcarriers
- excluded carriers that are set to zero

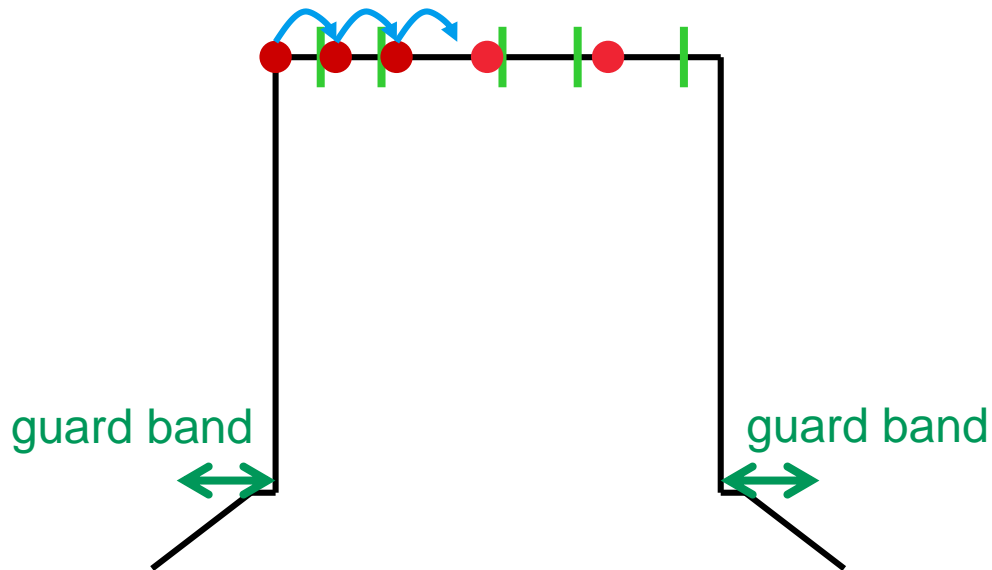

Pilots in DOCSIS 3.1

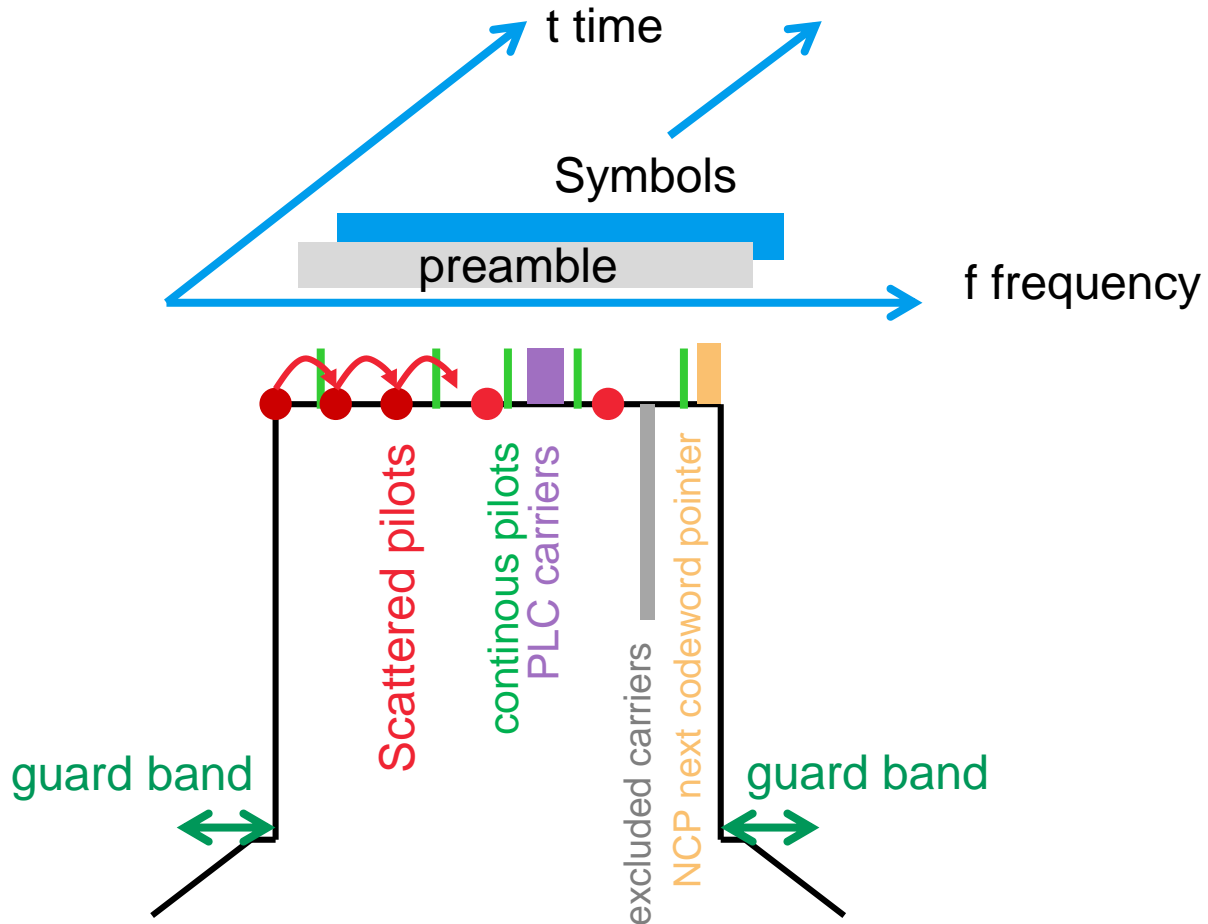

PLC = physical layer link channel

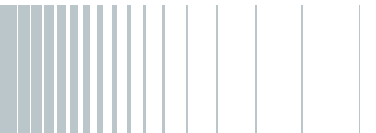

PLC – Physical Layer Link Channel

FFT size	Subcarrier spacing	Number of PLC subcarriers per symbol
4096	50 kHz	8
8192	25 kHz	16

PLC contains physical layer parameters for the cable modem (CM)

PLC consists of preamble and PLC data

Modulation of PLC carriers is BPSK for preamble and 16QAM for PLC data

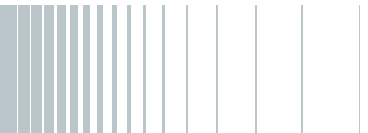

Profiles

NCP = Next Codeword Pointer = lowest layer; QPSK, 16QAM, 64QAM
NCP points to the beginning of the codewords of the profiles in a symbol

16 profiles (QPSK, ... 16KQAM)

Profile data are interleaved (interleaver depth 1...32)

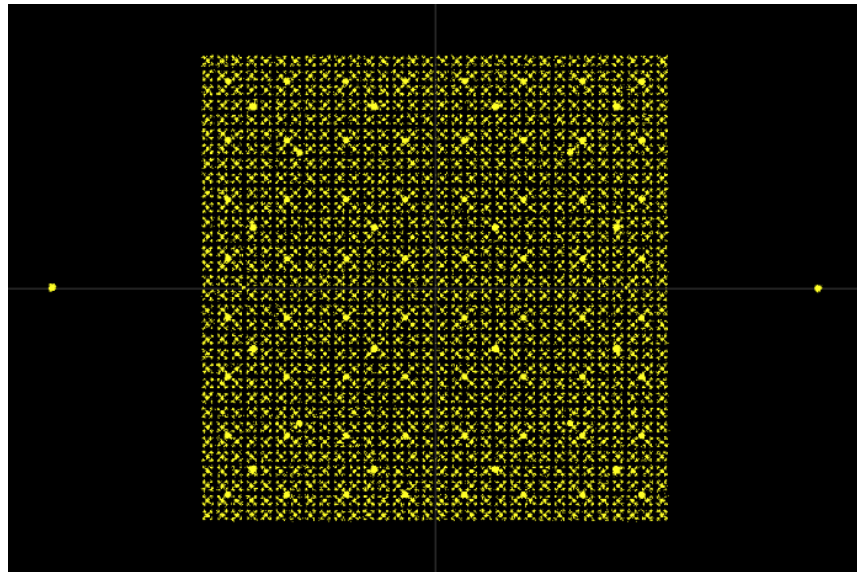

Profiles in DOCSIS 3.1 ...

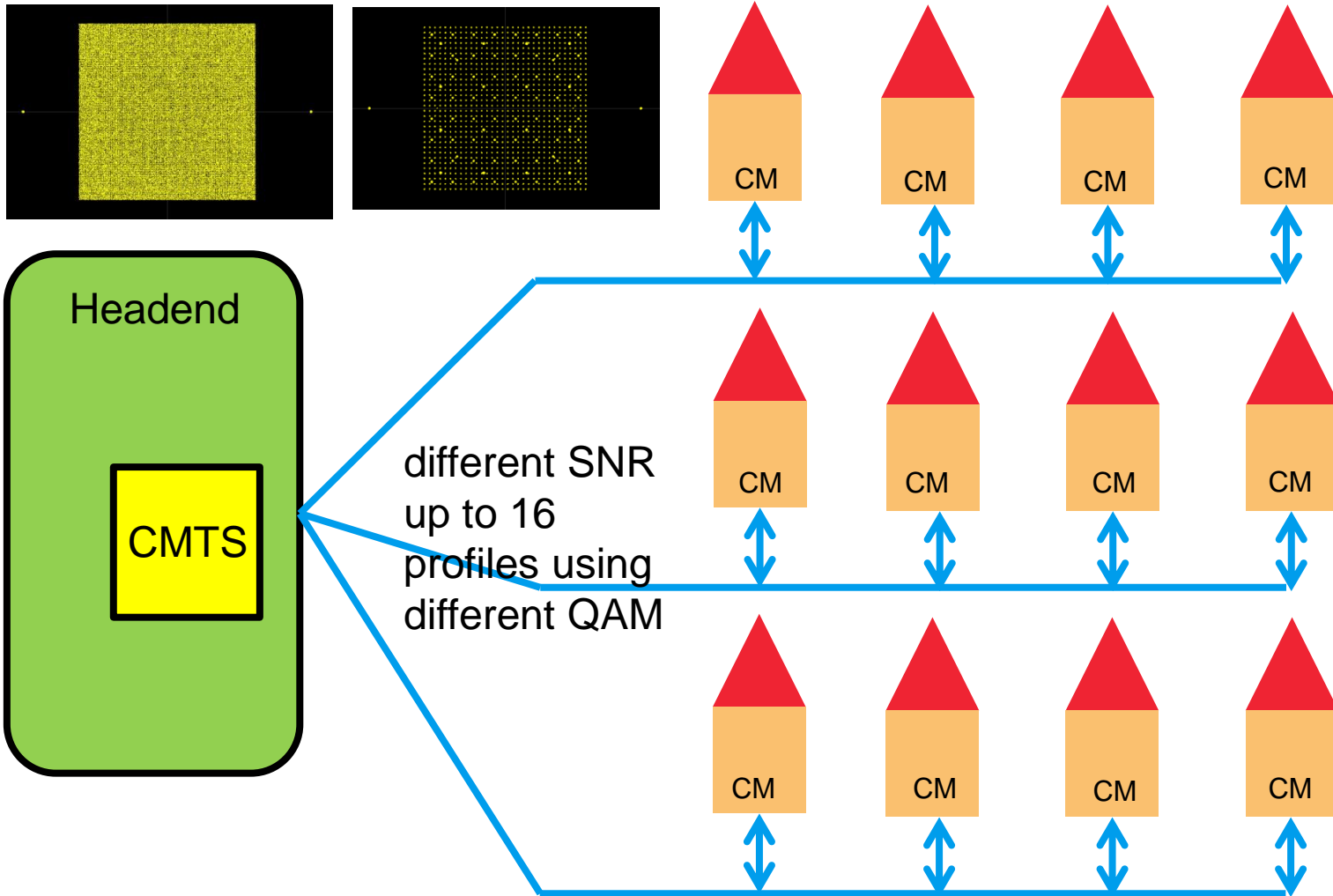

DOCSIS 3.1 Downstream Spectrum

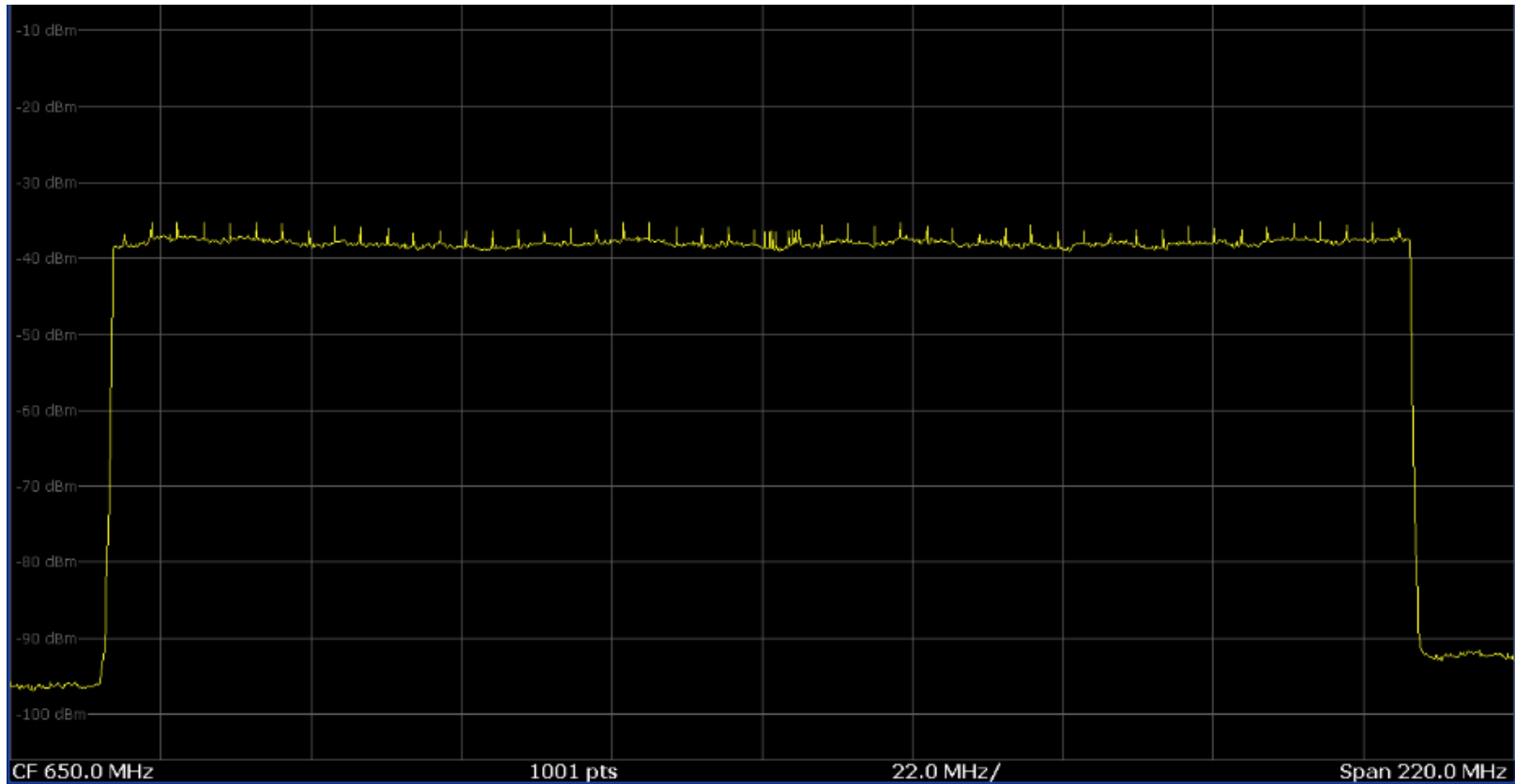

DOCSIS 3.1 Modulation Parameter

Modulation mode downstream	min CNR (AWGN) (... 1GHz)	min CNR (AWGN) (...1.2GHz)
16QAM	15.0 dB	15.0 dB
64QAM	21.0 dB	21.0 dB
128QAM	24.0 dB	24.0 dB
256QAM	27.0 dB	27.0 dB
512QAM	30.5 dB	30.5 dB
1024QAM	34.0 dB	34.0 dB
2048QAM	37.0 dB	37.5 dB
4096QAM	41.0 dB	41.5 dB
8192QAM		
16384QAM		

Modulation mode upstream	min CNR (AWGN)
QPSK	11.0 dB
8QAM	14.0 dB
16QAM	17.0 dB
32QAM	20.0 dB
64QAM	23.0 dB
128QAM	26.0 dB
256QAM	29.0 dB
512QAM	32.5 dB
1024QAM	35.5 dB
2048QAM	39.0 dB
4096QAM	43.0 dB



DOCSIS 3.1 Constellation Diagram, No Payload, only PLC and Pilots

PLC = physical layer link channel

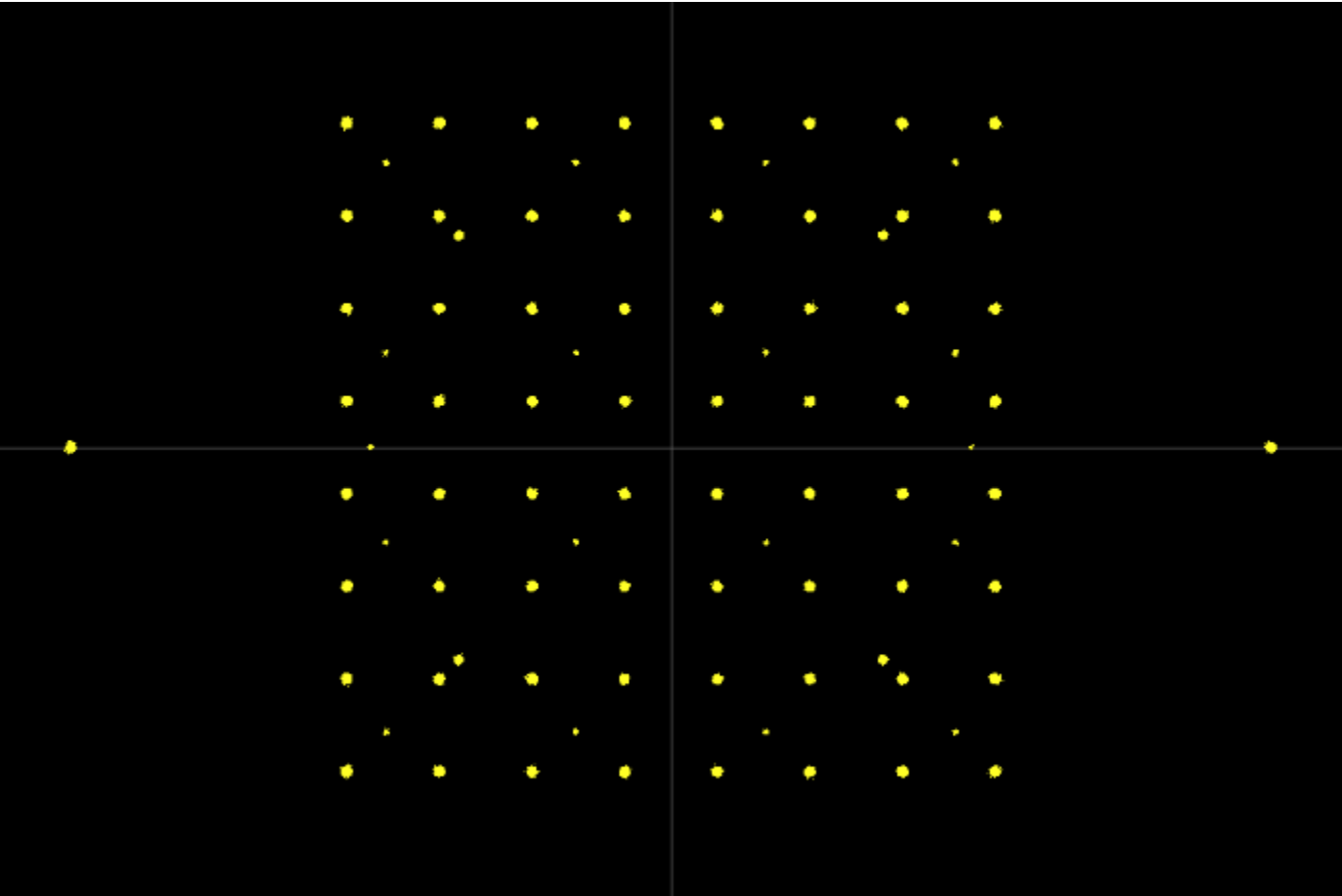

DOCSIS 3.1 Downstream, Pilots, Signalling and 64QAM Payload Profile

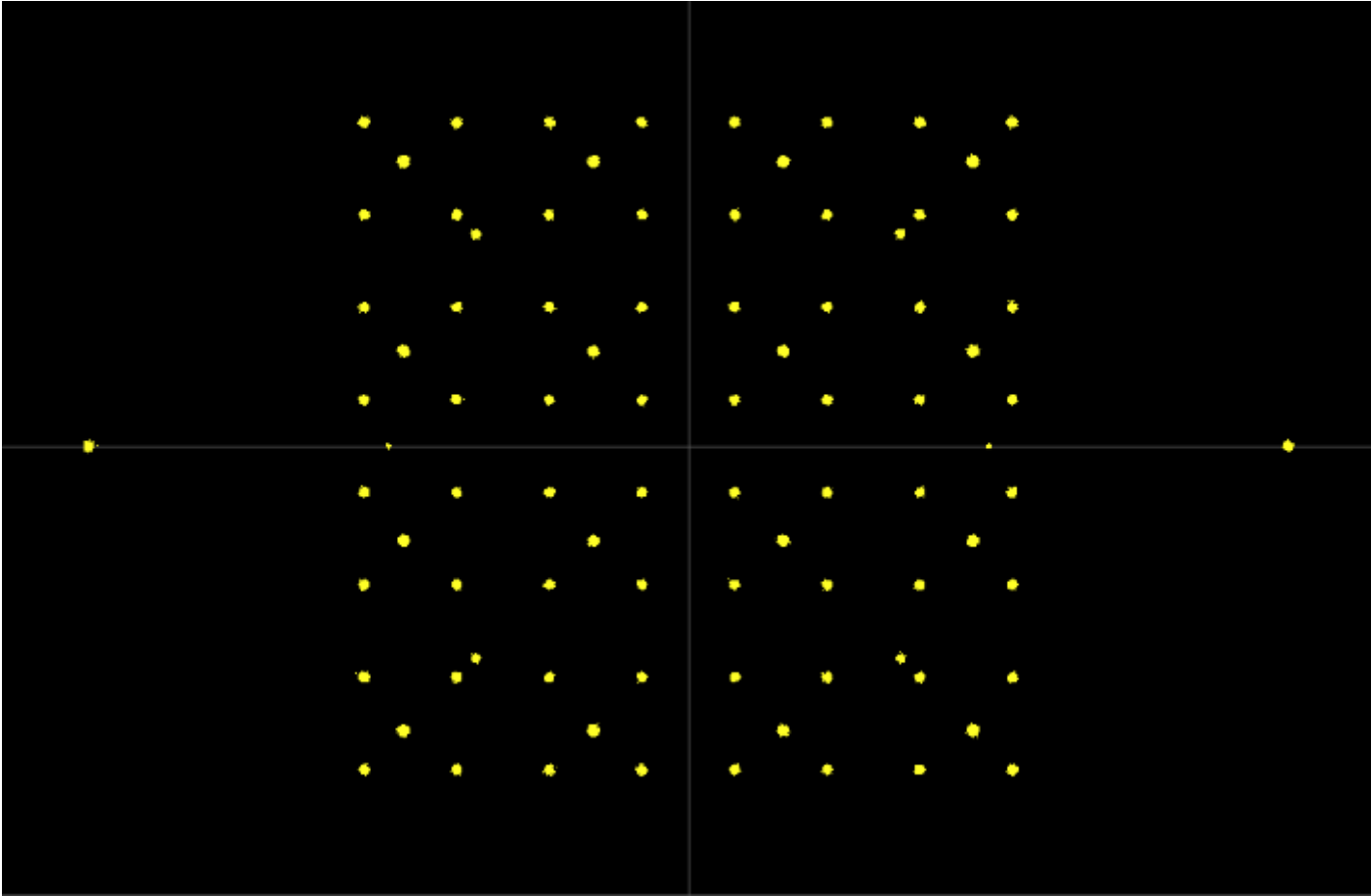

DOCSIS 3.1 Downstream, Pilots, Signalling, 64QAM, 256QAM Payload Profile

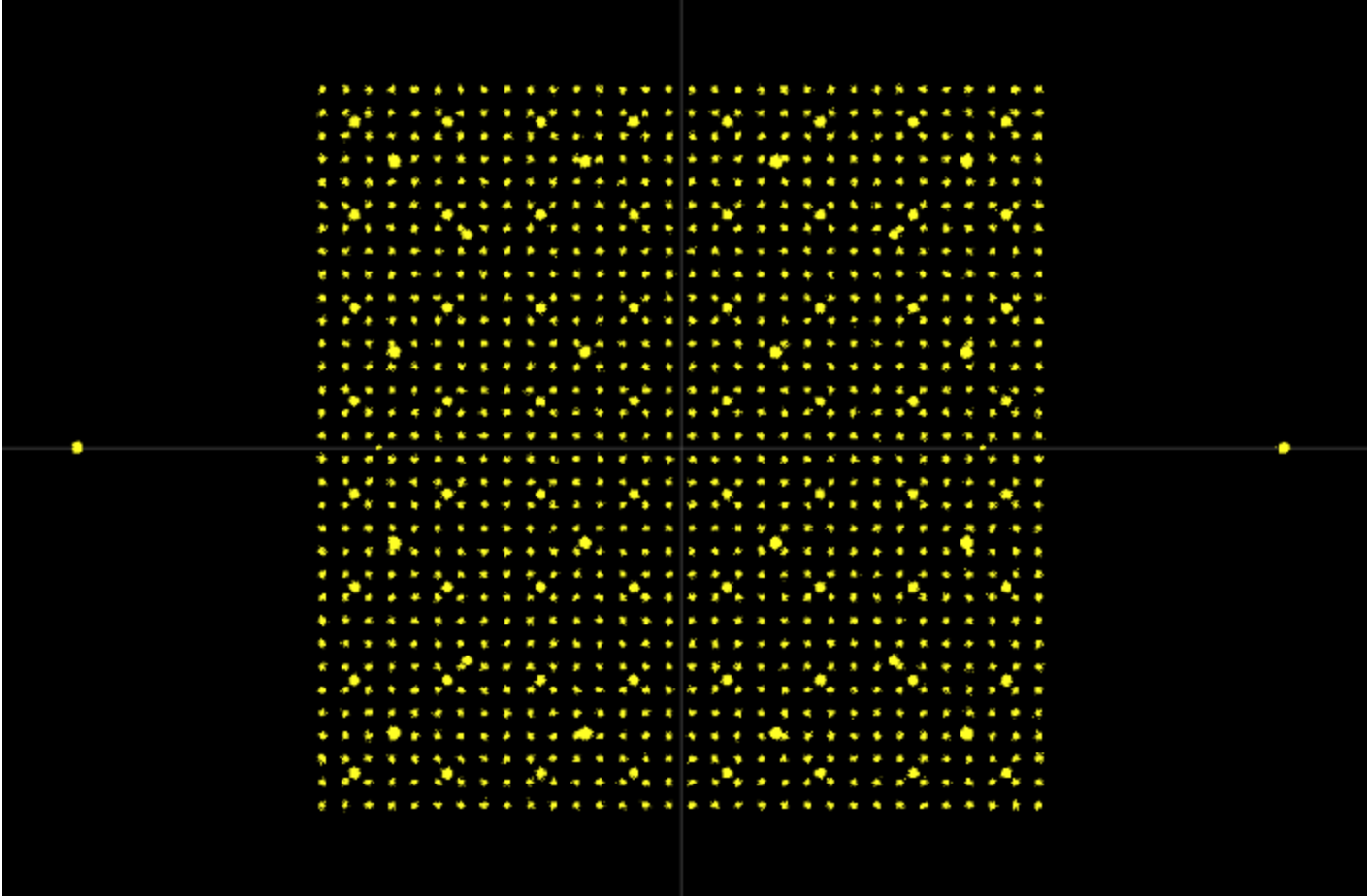

DOCSIS 3.1, ... 1024QAM

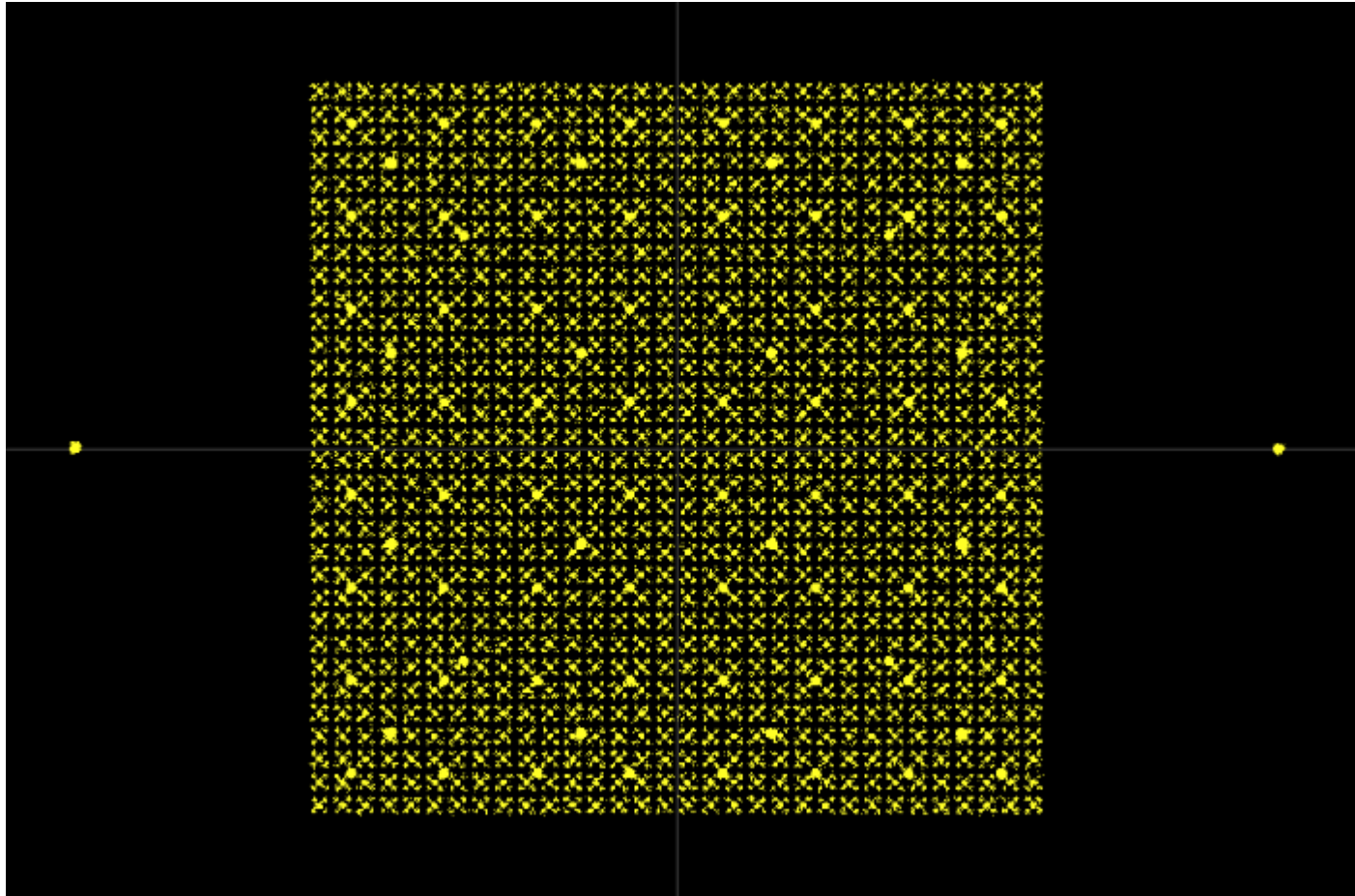

DOCSIS 3.1 Downstream, ... 4096QAM

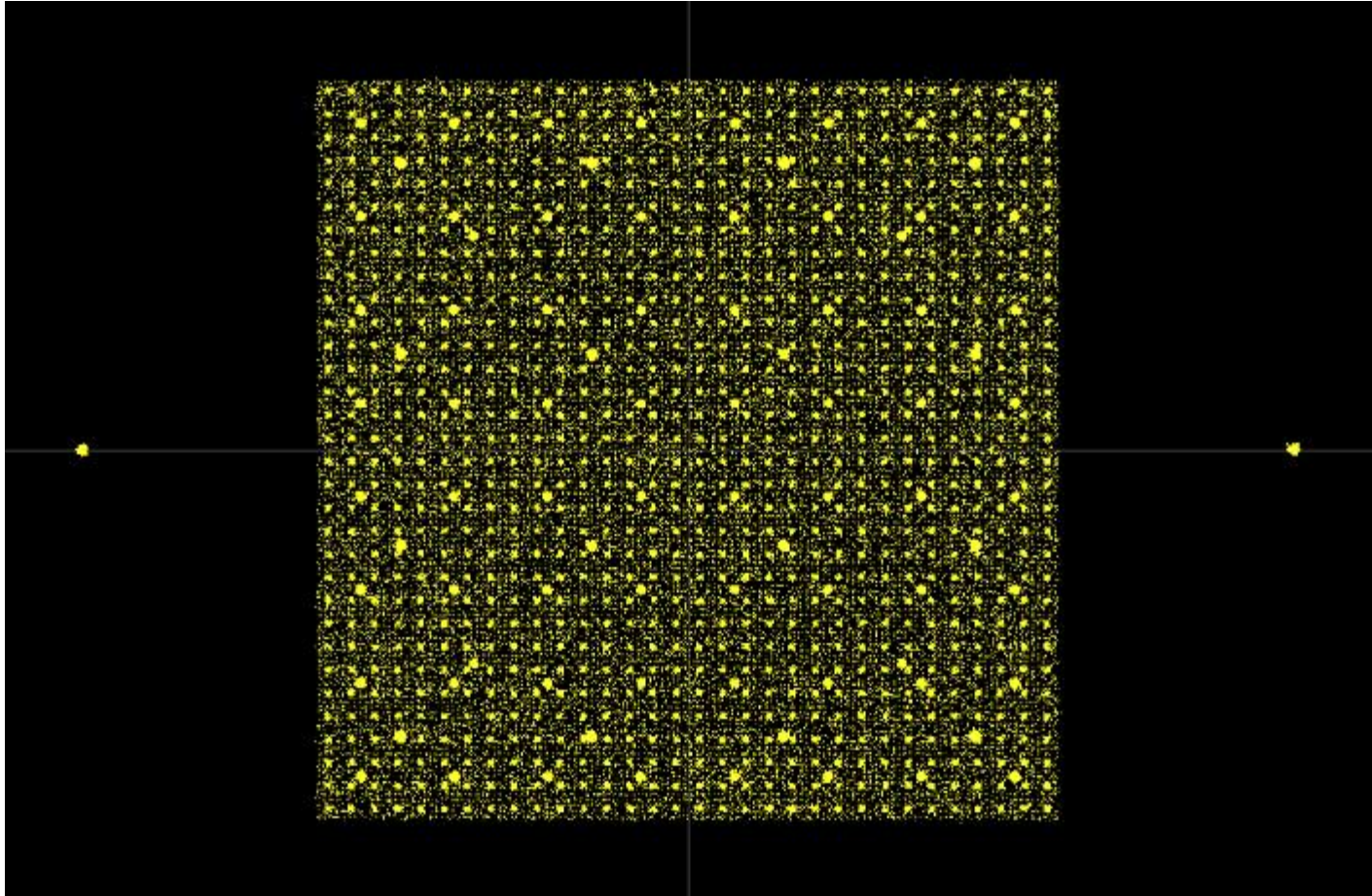

DOCSIS 3.1, ... 16KQAM

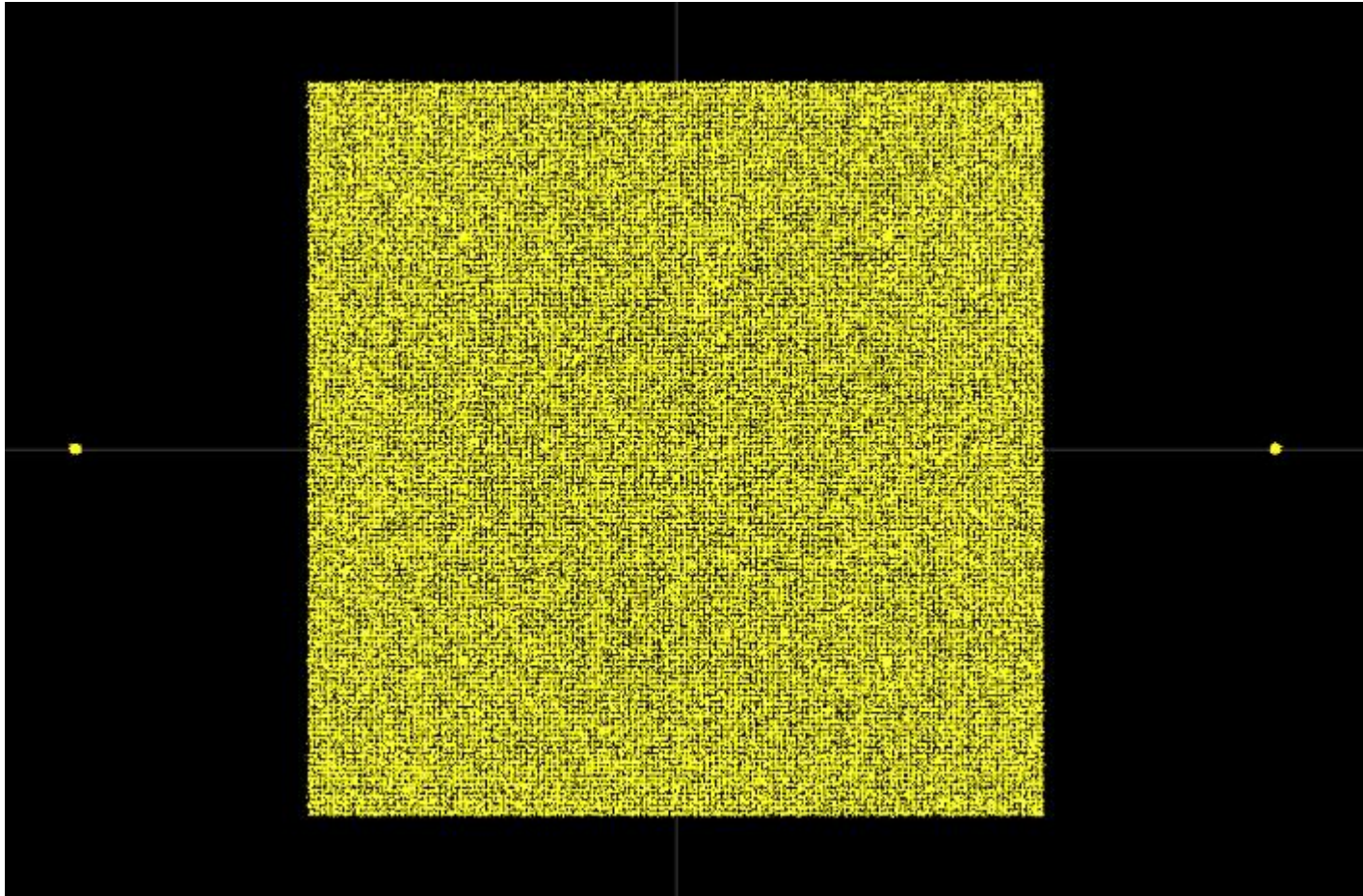

Guard Interval / CP before and behind of the Symbol

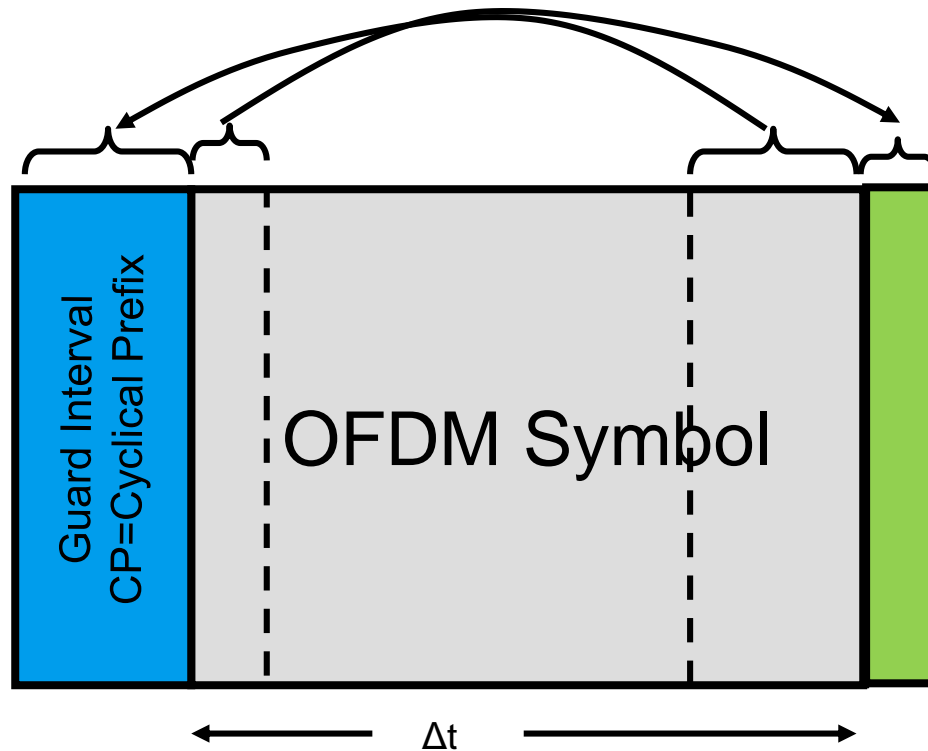

(... DOCSIS3.1 symbol duration ... 20 or 40 μs ... OFDM, 1...5 μs guard)

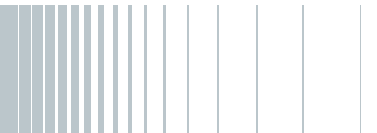

Guard Interval & Windowing

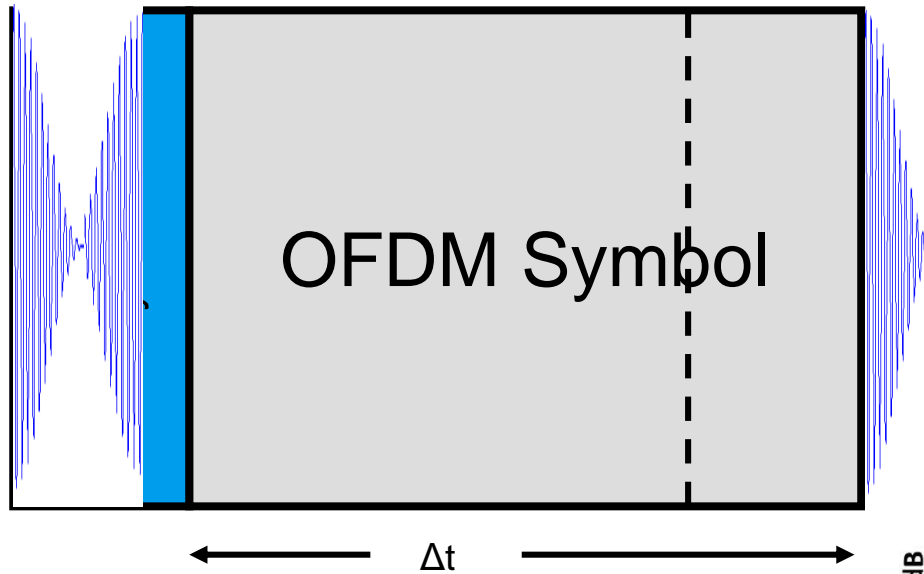

Tukey-rised cosine windowing
in DOCSIS 3.1

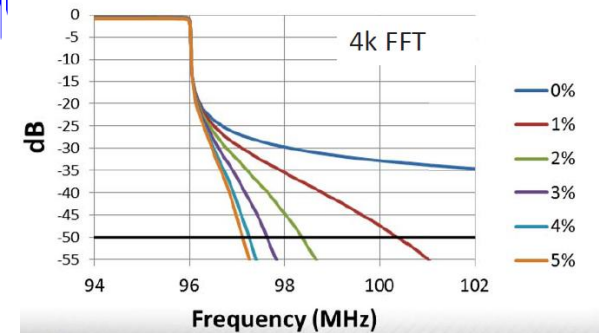

(... DOCSIS3.1 symbol duration ... 20 or 40 μ s ... OFDM, 1...5 μ s guard)

DOCSIS 3.1 Cyclic Prefix ... Downstream

CP length downstream 4K / 8K	CP length in elementary periodes
0.9376 μ s	$192 \cdot T_{SD}$
1.25 μ s	$256 \cdot T_{SD}$
2.5 μ s	$512 \cdot T_{SD}$
3.75 μ s	$768 \cdot T_{SD}$
5 μ s	$1024 \cdot T_{SD}$

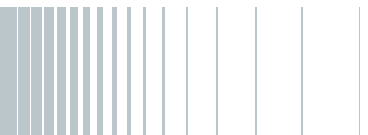

DOCSIS 3.1 Cyclic Prefix

CP length upstream 2K / 4K mode	CP length in elementary periodes
0.9376 μ s	$96 \cdot T_{SU}$
1.25 μ s	$128 \cdot T_{SU}$
1.5625 μ s	$160 \cdot T_{SU}$
1.875 μ s	$192 \cdot T_{SU}$
2.1875 μ s	$224 \cdot T_{SU}$
2.5 μ s	$256 \cdot T_{SU}$
2.8125 μ s	$288 \cdot T_{SU}$
3.125 μ s	$320 \cdot T_{SU}$
3.75 μ s	$384 \cdot T_{SU}$
5.0 μ s	$512 \cdot T_{SU}$
6.25 μ s	$640 \cdot T_{SU}$

CP length downstream 4K / 8K	CP length in elementary periodes
0.9376 μ s	$192 \cdot T_{SD}$
1.25 μ s	$256 \cdot T_{SD}$
2.5 μ s	$512 \cdot T_{SD}$
3.75 μ s	$768 \cdot T_{SD}$
5 μ s	$1024 \cdot T_{SD}$



DOCSIS 3.1 FEC – Forward Error Correction

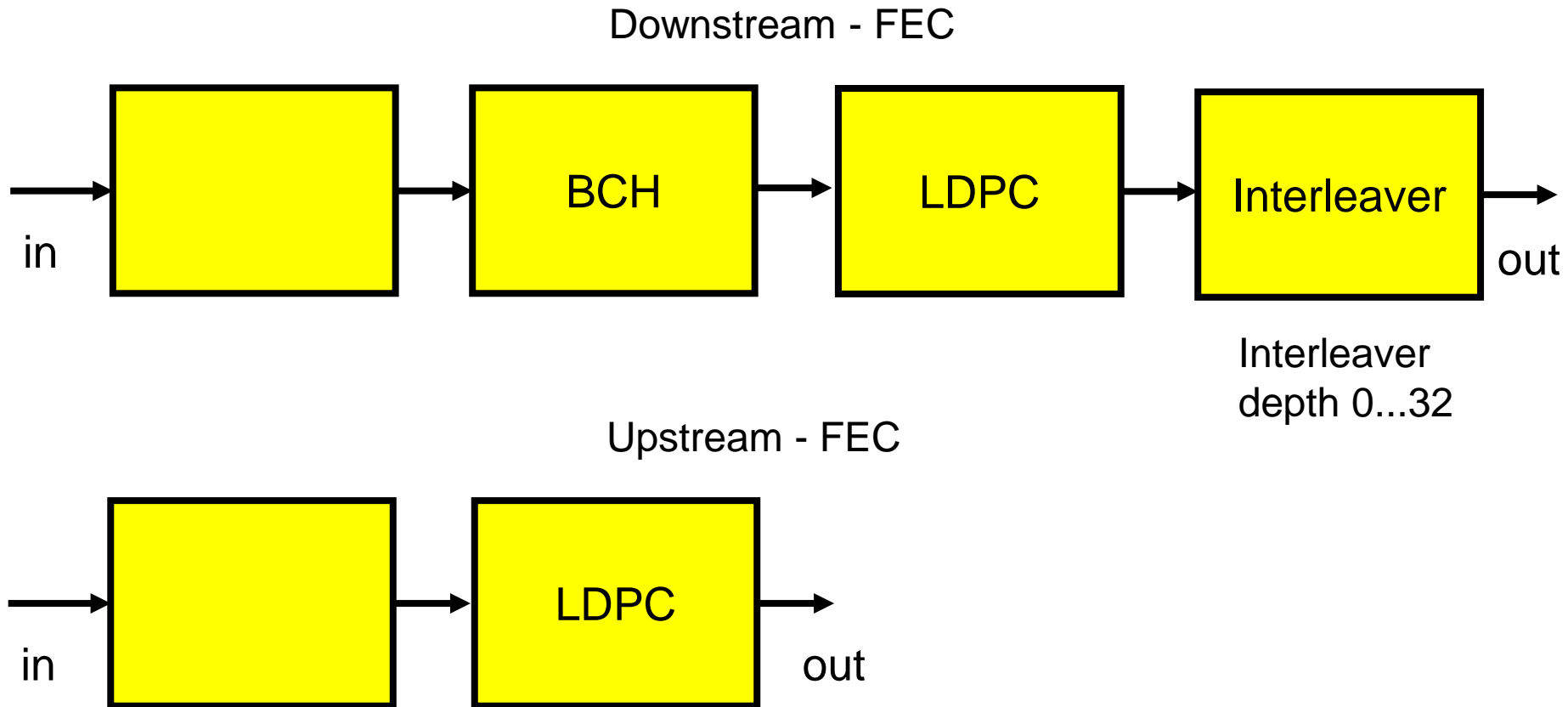

FSW DOCSIS 3.1 Analysis

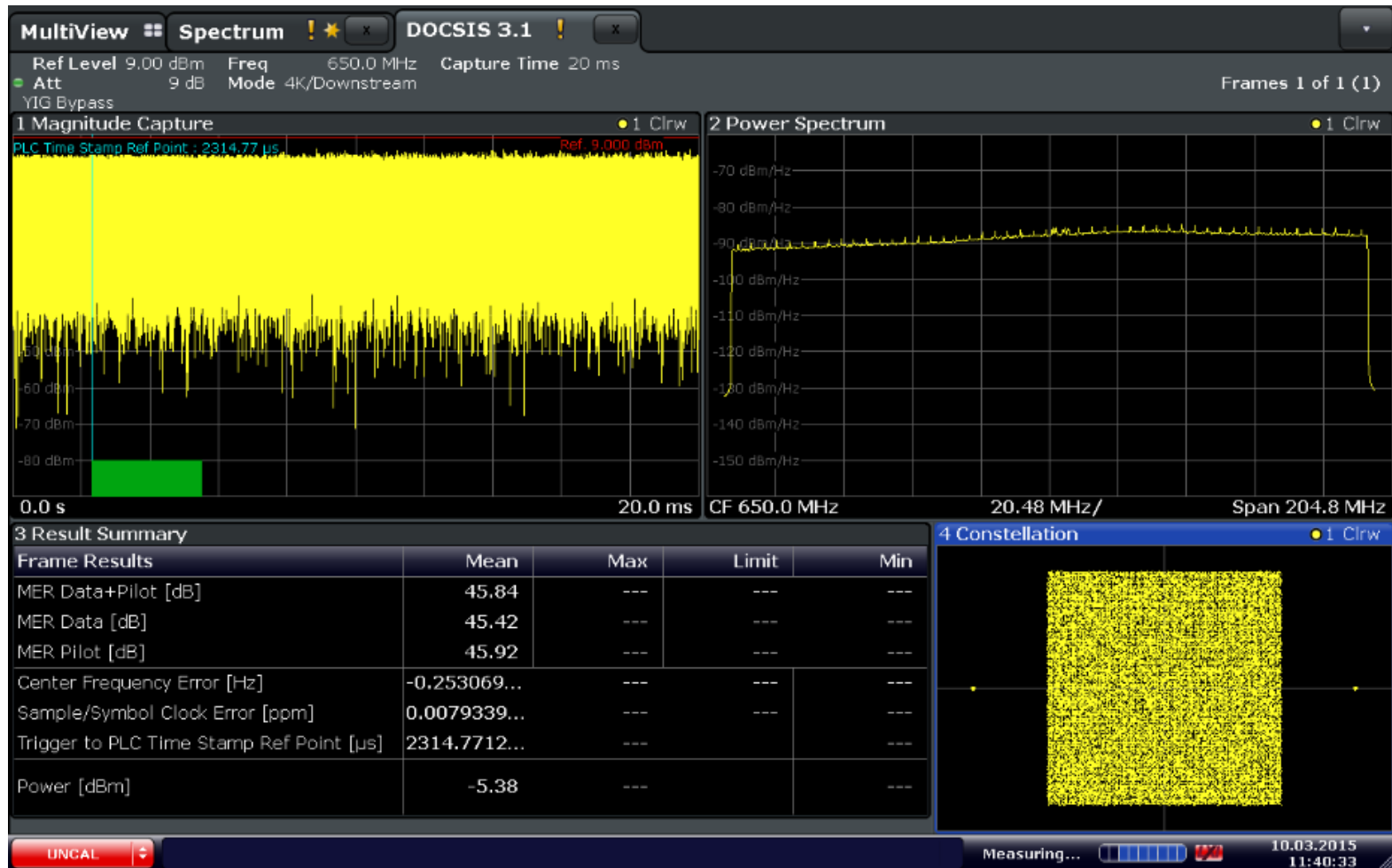

From DVB-C2 to DOCSIS 3.1

DOCSIS Intro and Principle

Single Carrier Modulation Principle

Time Domain and Spectrum Domain

QAM and SNR Requirement

OFDM Basics, OFDM in CATV

DOCSIS 3.1 Physical Layer Parameters

DOCSIS 3.1 Demo Transmission



CLGD ... Simulating Multichannel CATV Load

ATV
DVB-C
DOCSIS



SFD ... Single Channel DOCSIS 3.0/3.1/ARB Generator



DOCSIS 3.1 Signal Analysis ... using R&S FSW

R&S FSW-K192 DOCSIS 3.1 Downstream Measurement Application

R&S FSW-K193 DOCSIS 3.1 Upstream Measurement Application



R&S DSA – DOCSIS Signal Analyzer

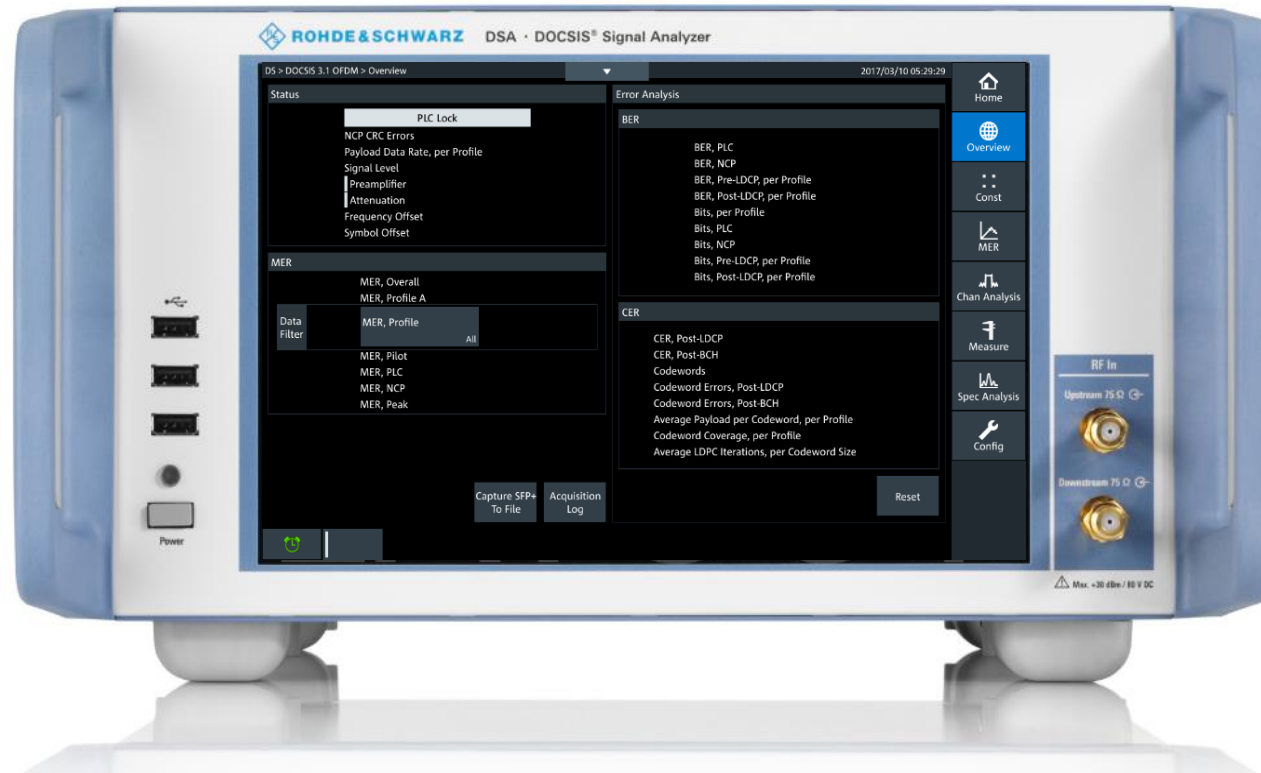

CATV Demo Transmission Link

Source
„CATV“ Headend
signal source:
SFD
CLDG
BTC

Optical link

3 CATV amplifier plus
coax cable simulation

Sink
„CATV“
enduser equipment
analyzer:
ETL
FSW



Demo setup in Teisnach, Germany, June 2016



CATV Demo Transmission Link

Optical fibre link

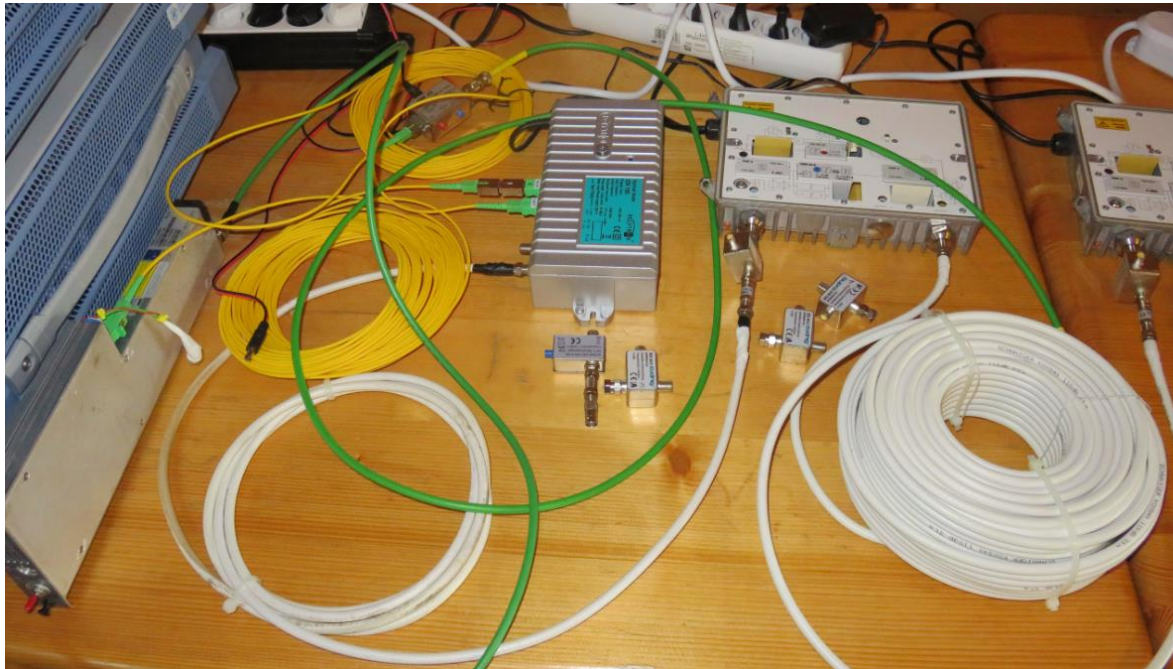

Laser

Optical node



CATV Demo Transmission Link

3 CATV amplifier plus
coax cable simulation



DOCSIS3.1 – Signal from CLGD, measured with FSW

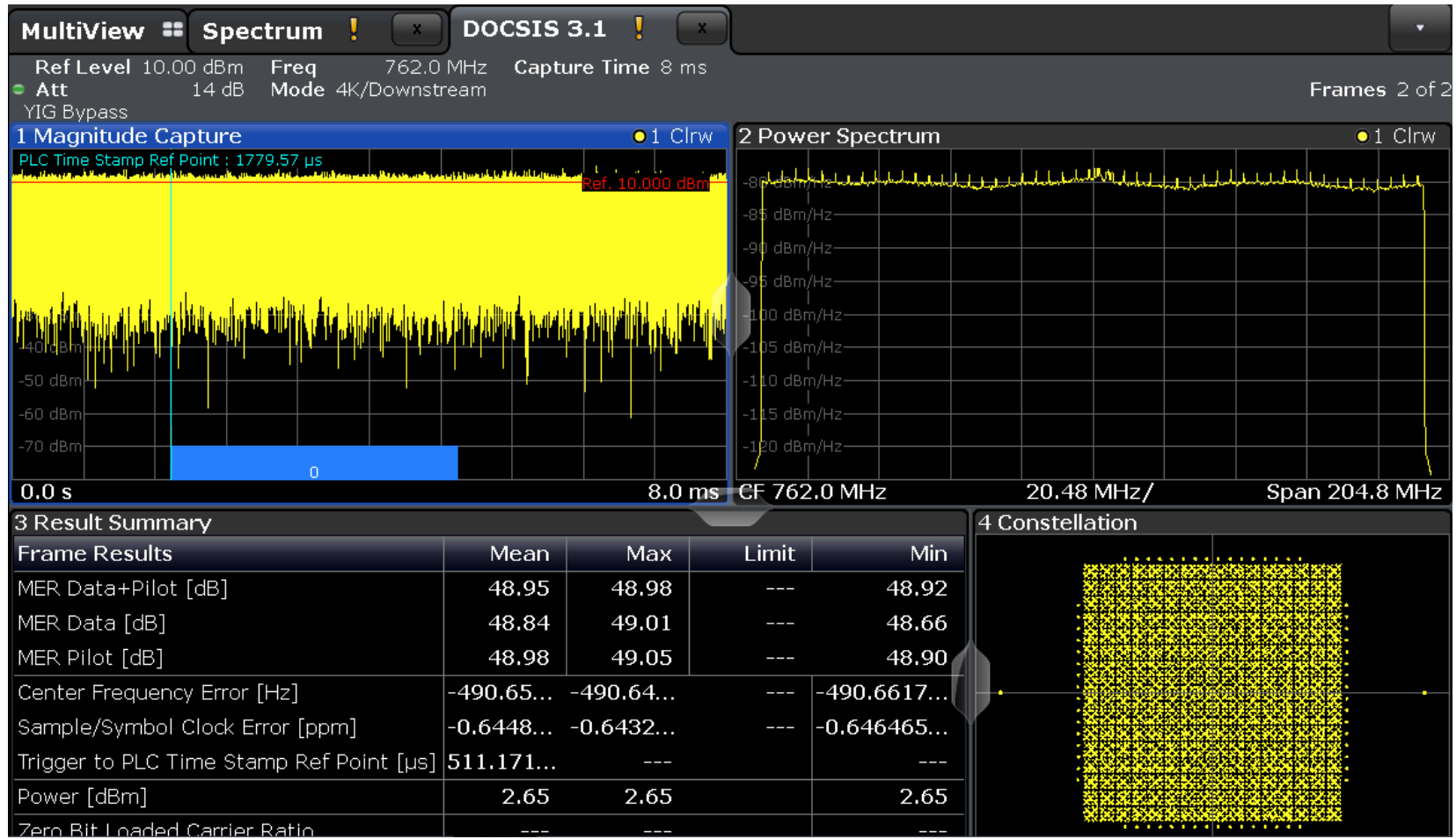

CLGD Signal (DVB-C Multi-Channel and DOCSIS3.1)

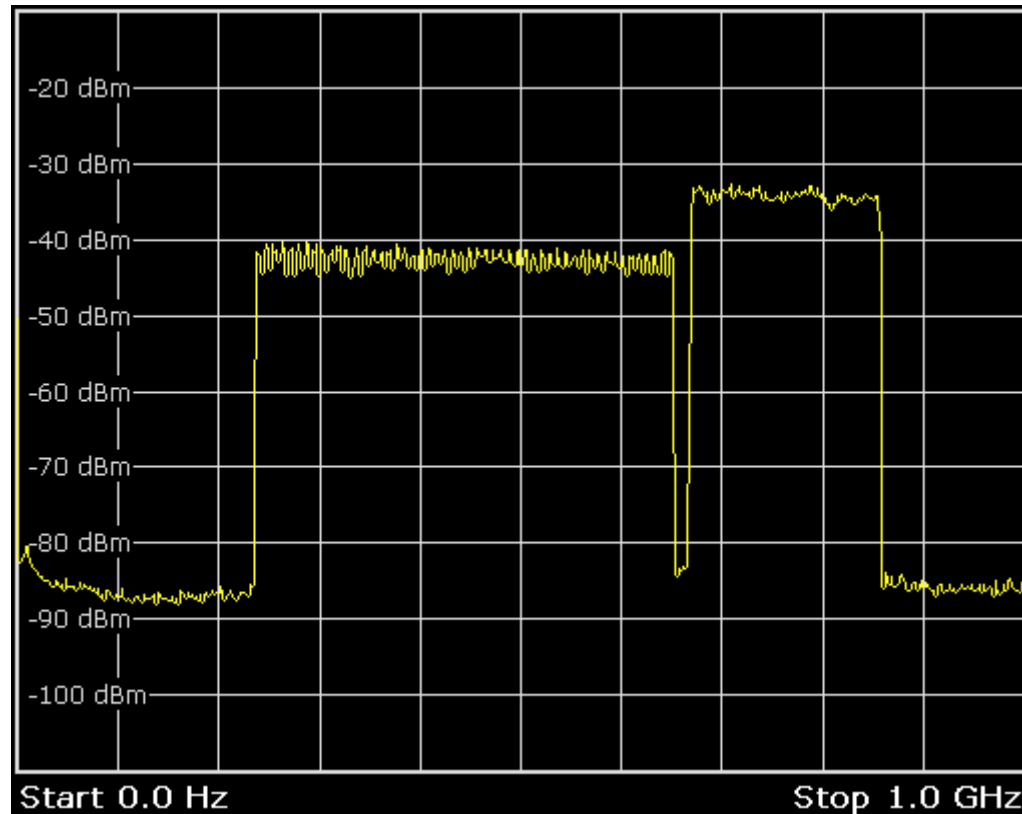

Single DVB-C Signal from SFU

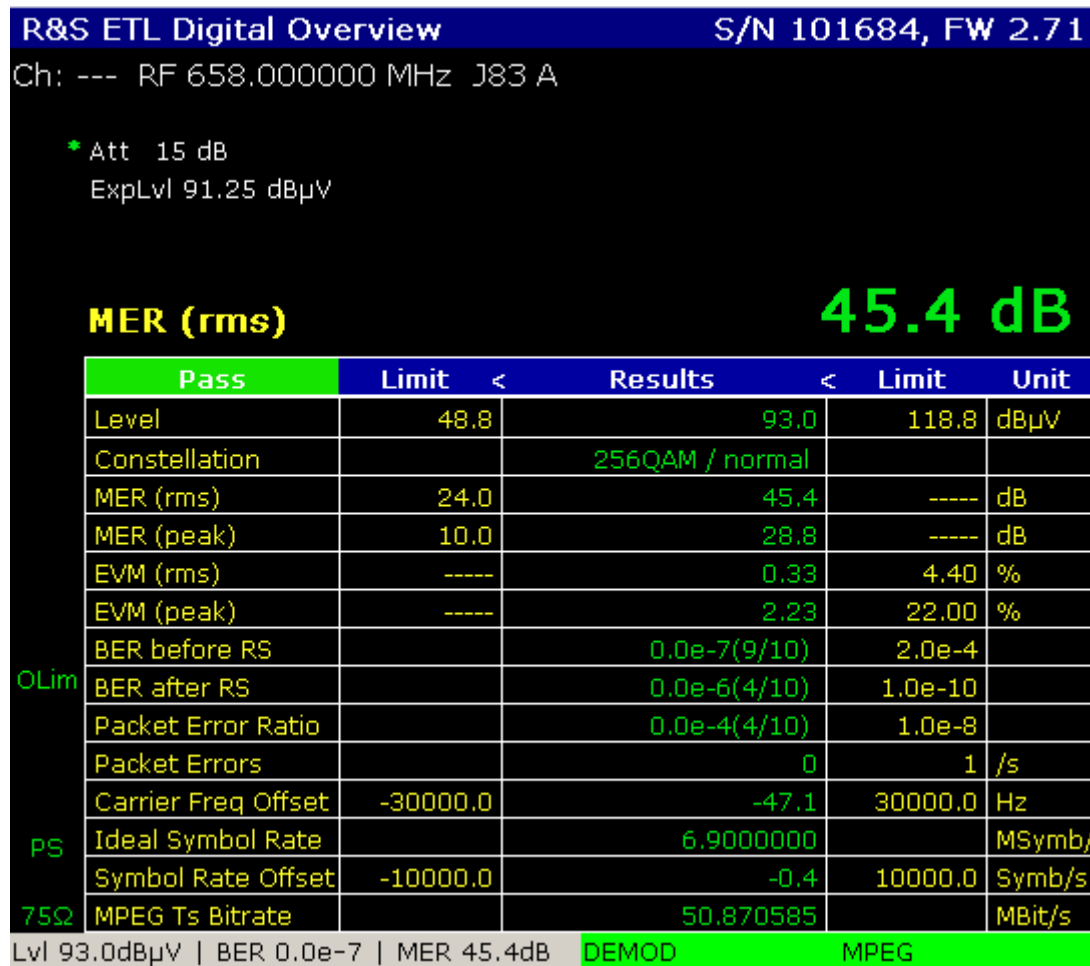

Signal before Optical Link at Network Input

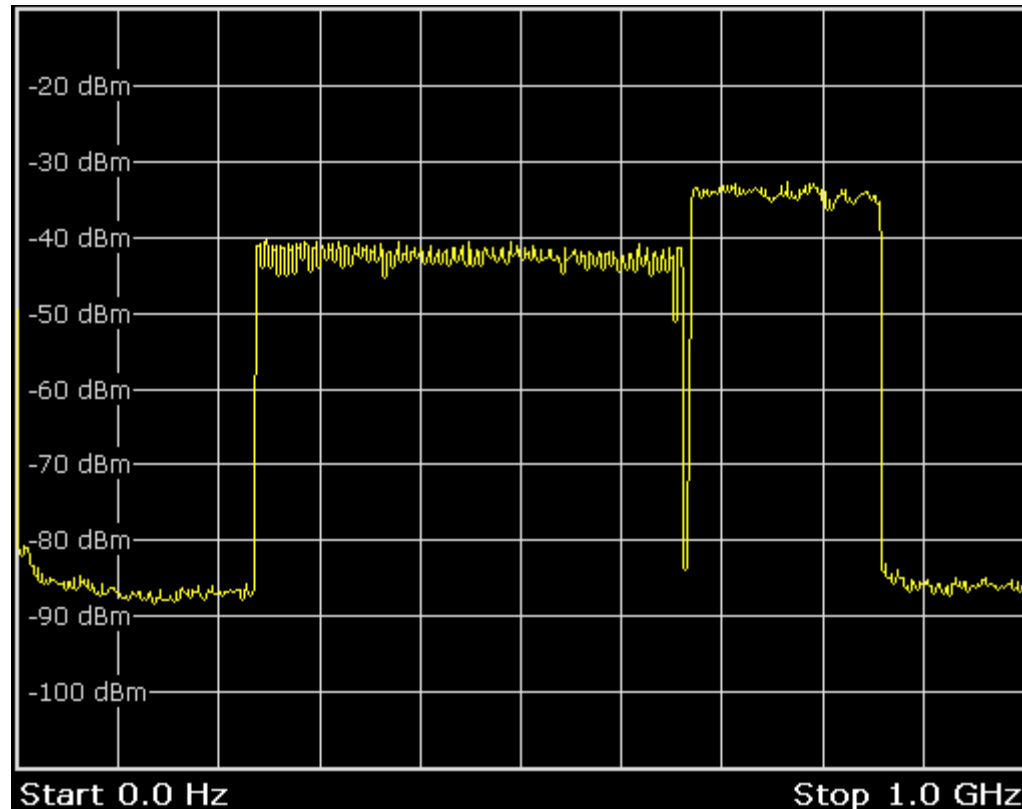

DOCSIS at Network Input

MER = 48 dB

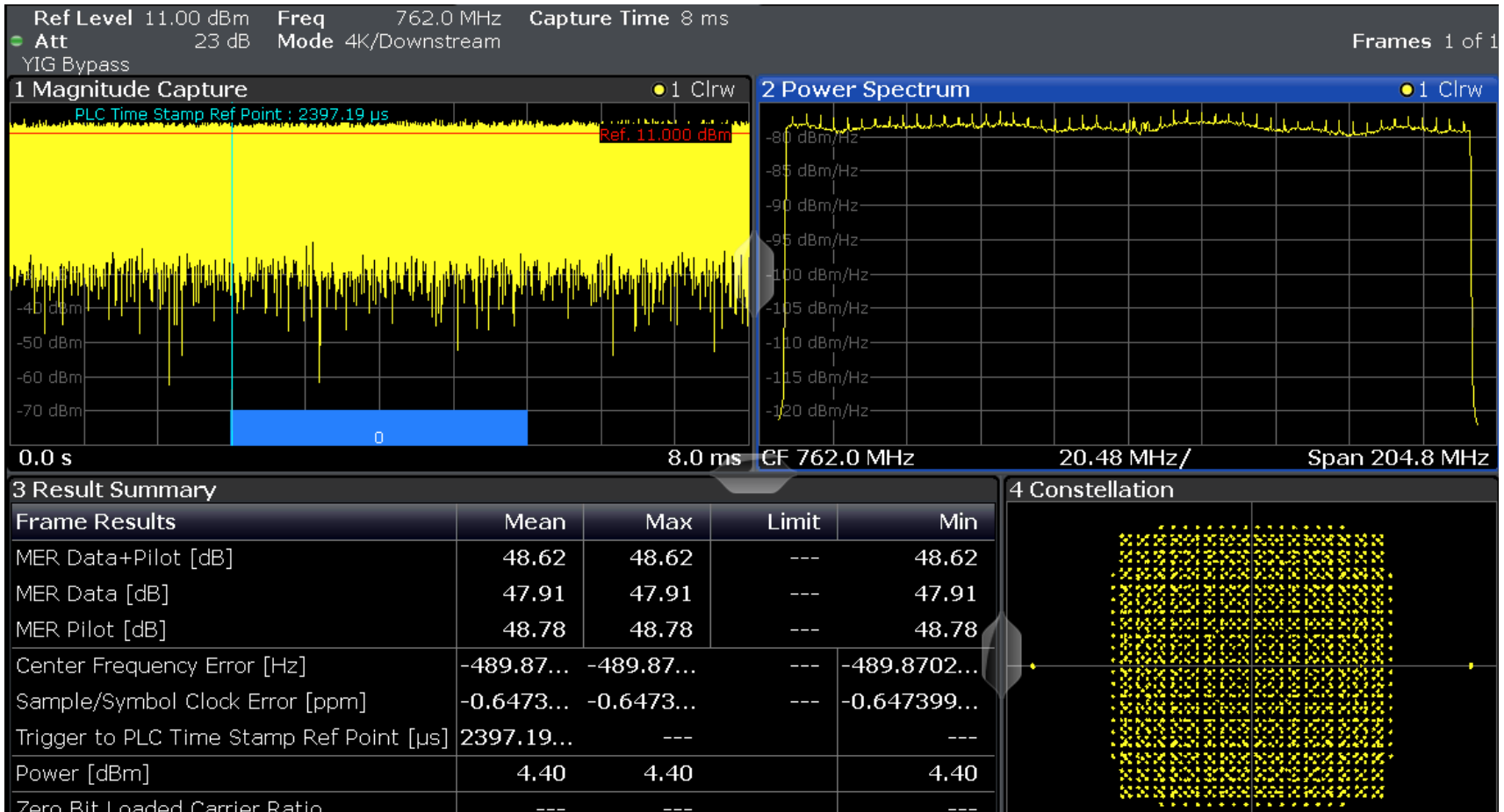

DOCSIS - 1024QAM at the Input of the Cascade (CLGD Output)

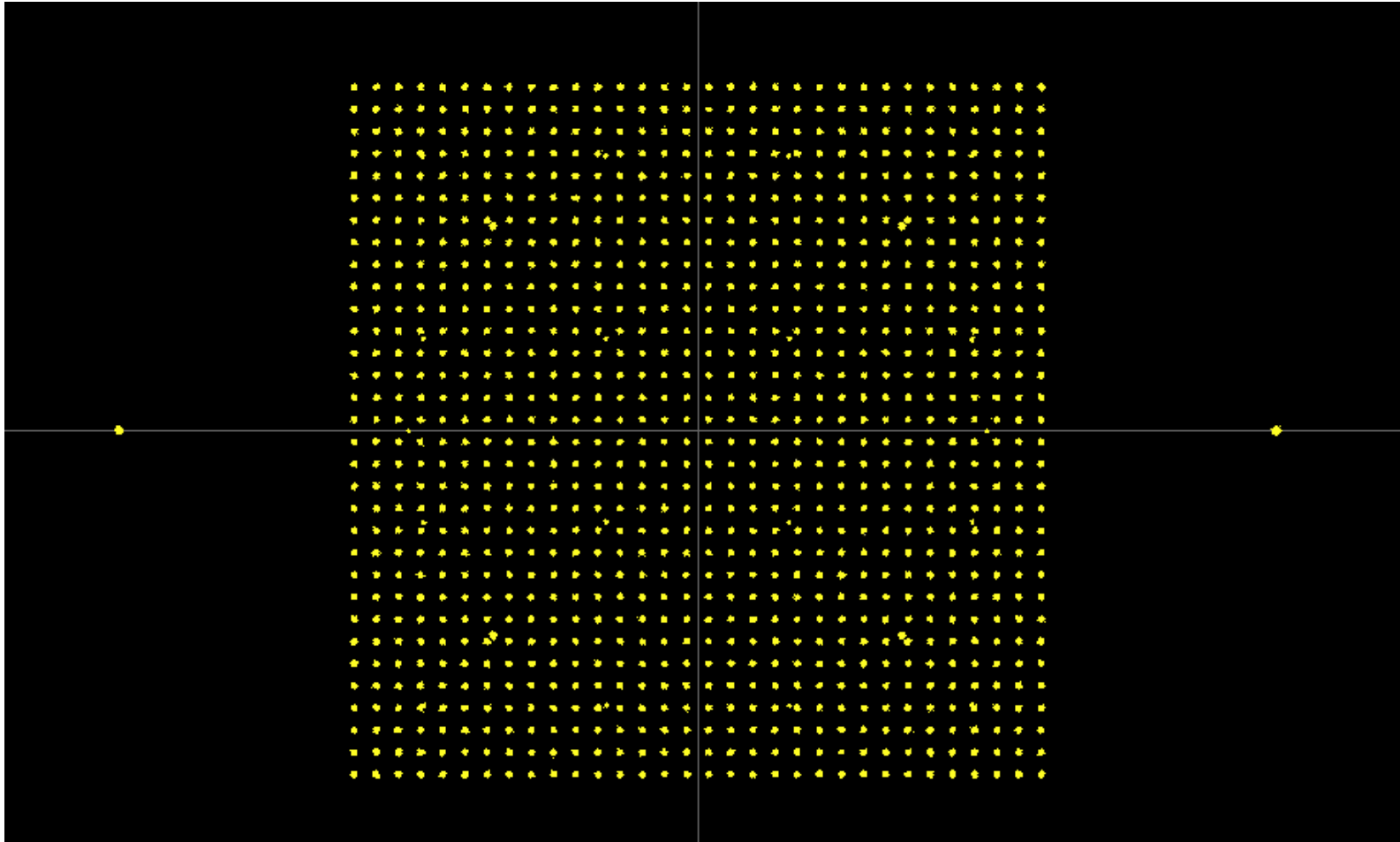

DOCSIS - 4kQAM at CLGD Output (Begin of Cascade)

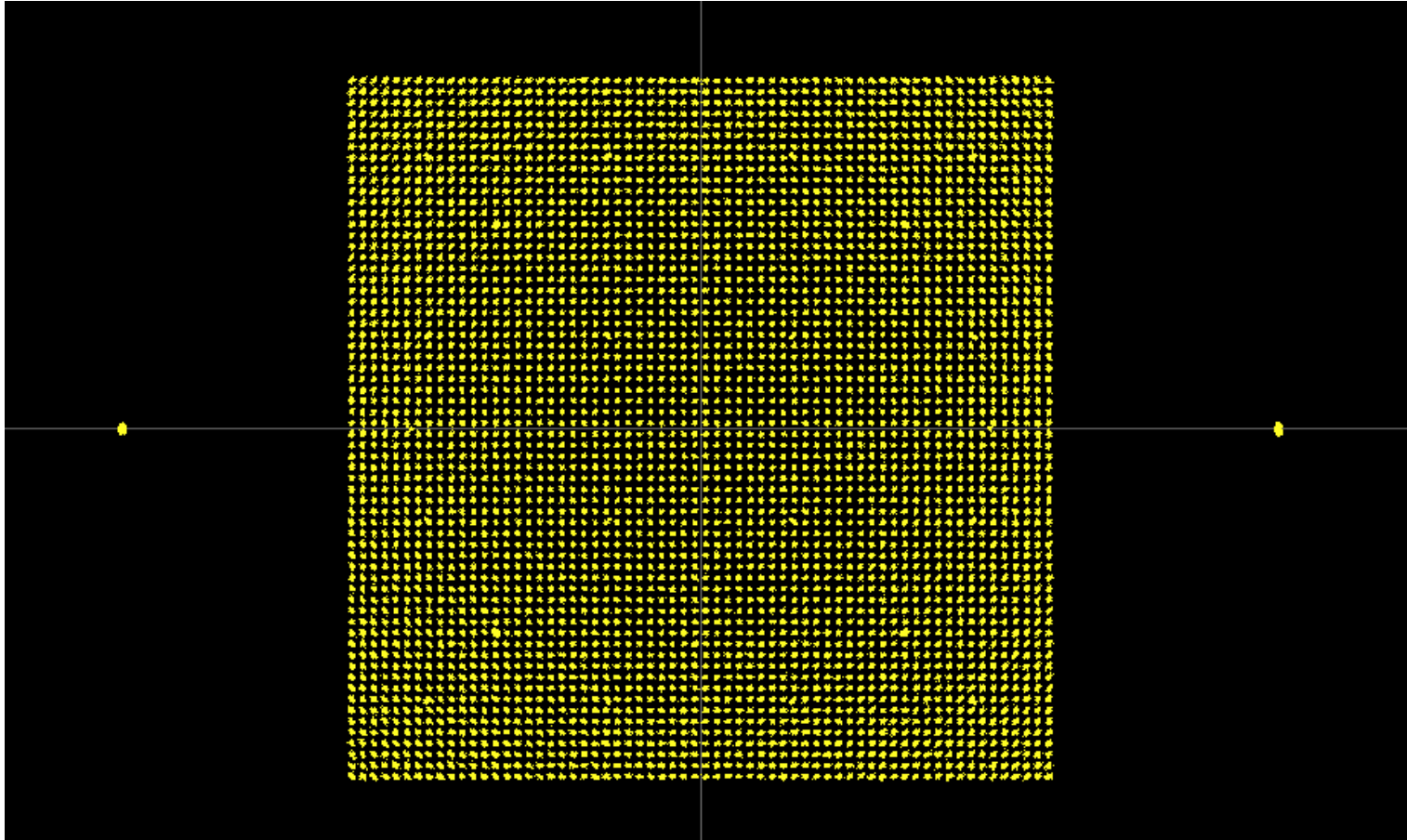

DOCSIS - 16kQAM at CLGD Output (Begin of Cascade)

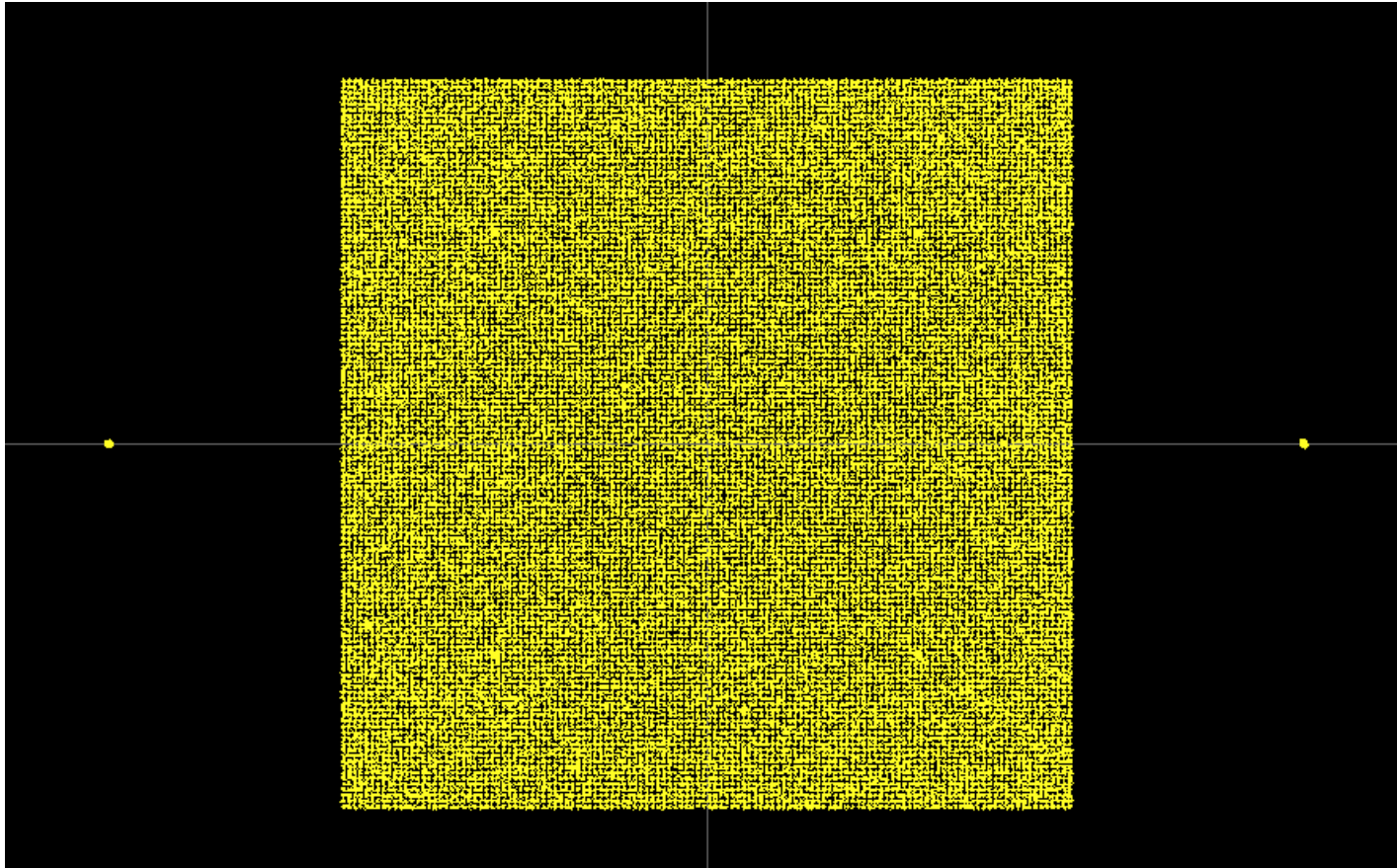

Spectrum, after Optical Link

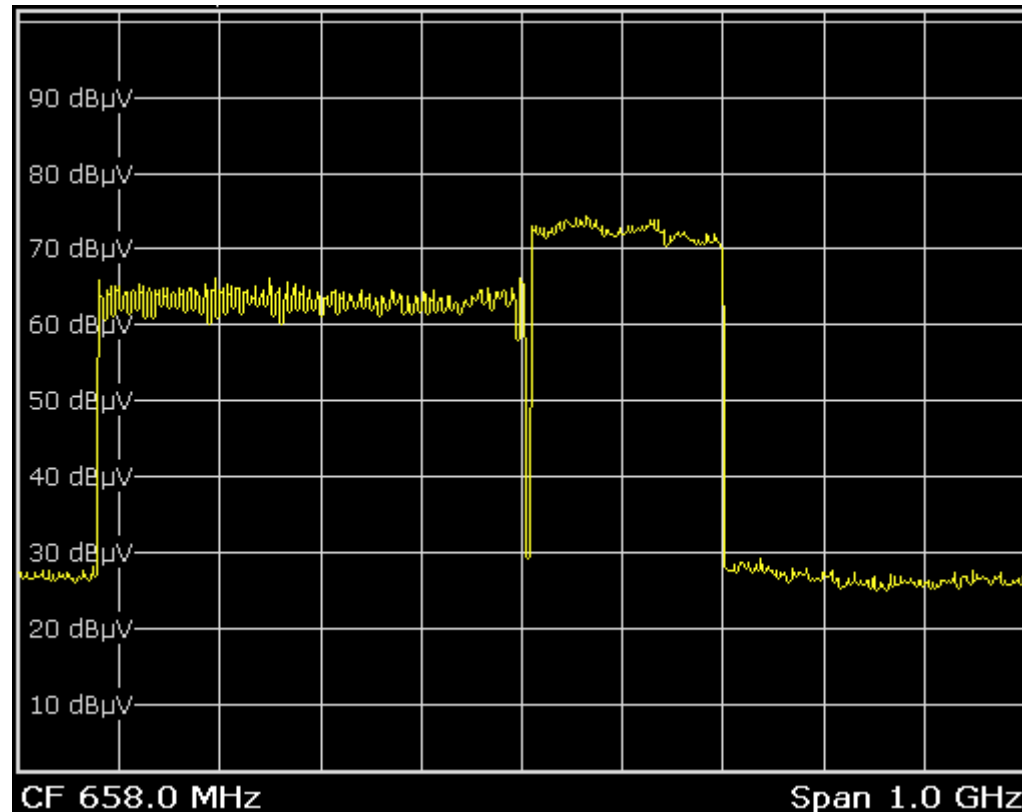

Spectrum after 3rd Amplifier

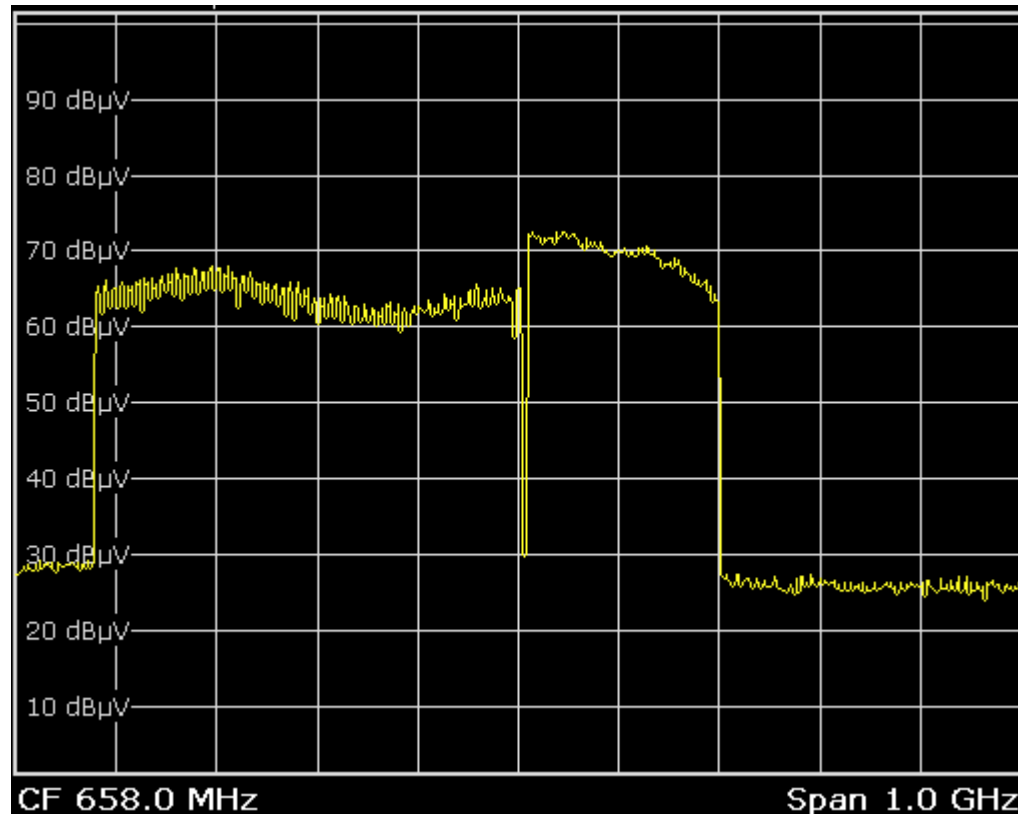

DOCSIS3.1 after Optical Link

MER = 43 dB

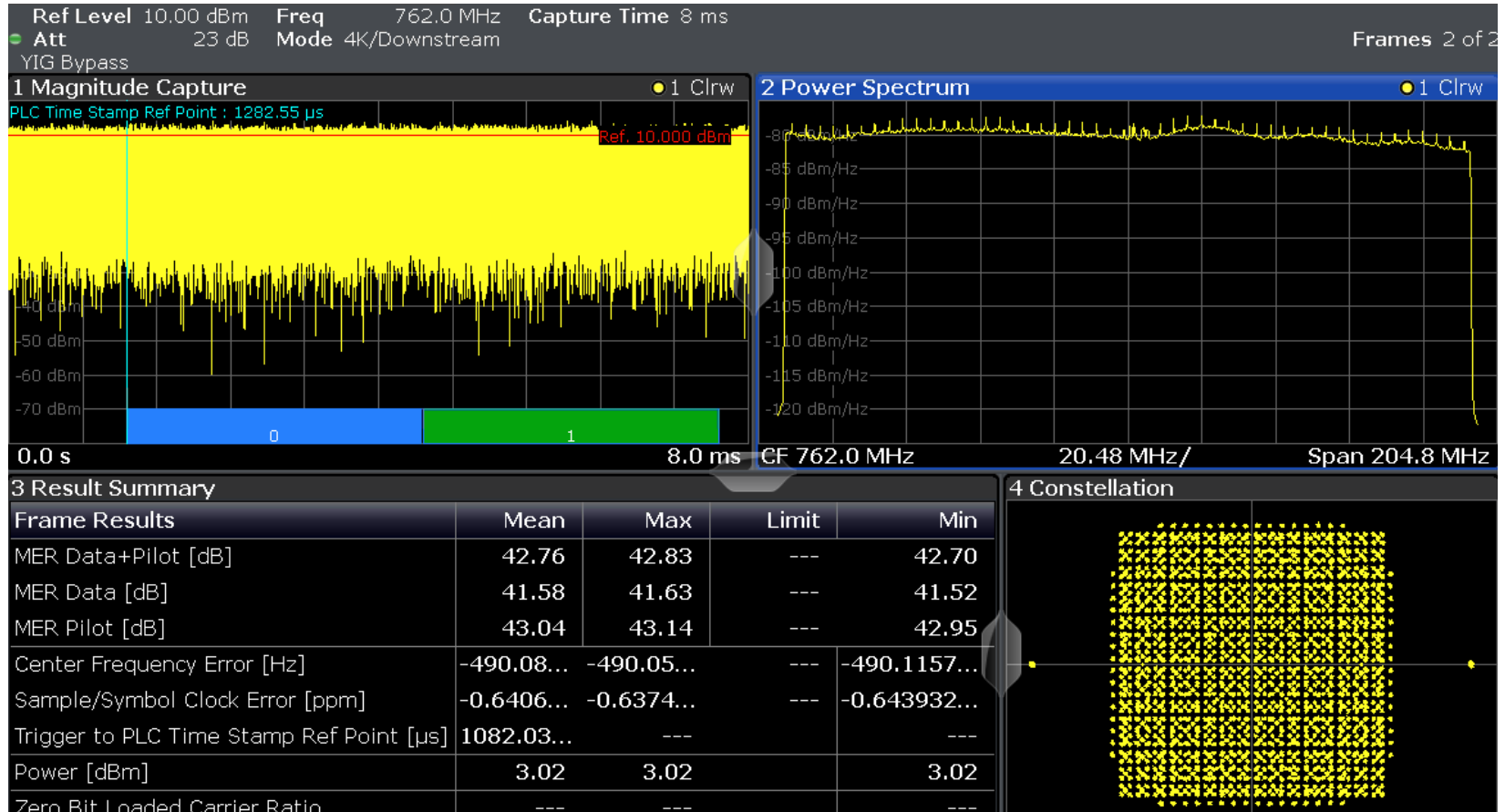

DVB-C at the End of the Cascade

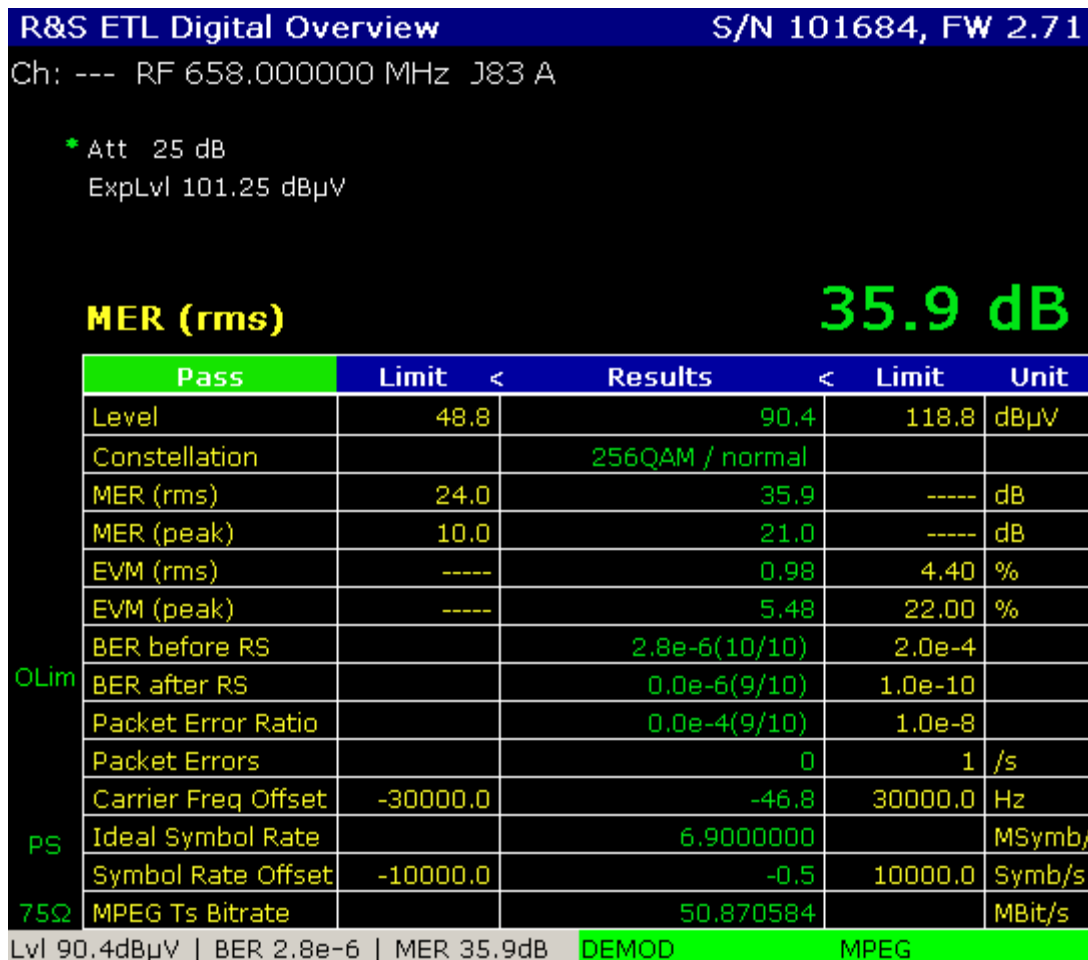

DOCSIS3.1 at the End of the Cascade

MER = 37 dB

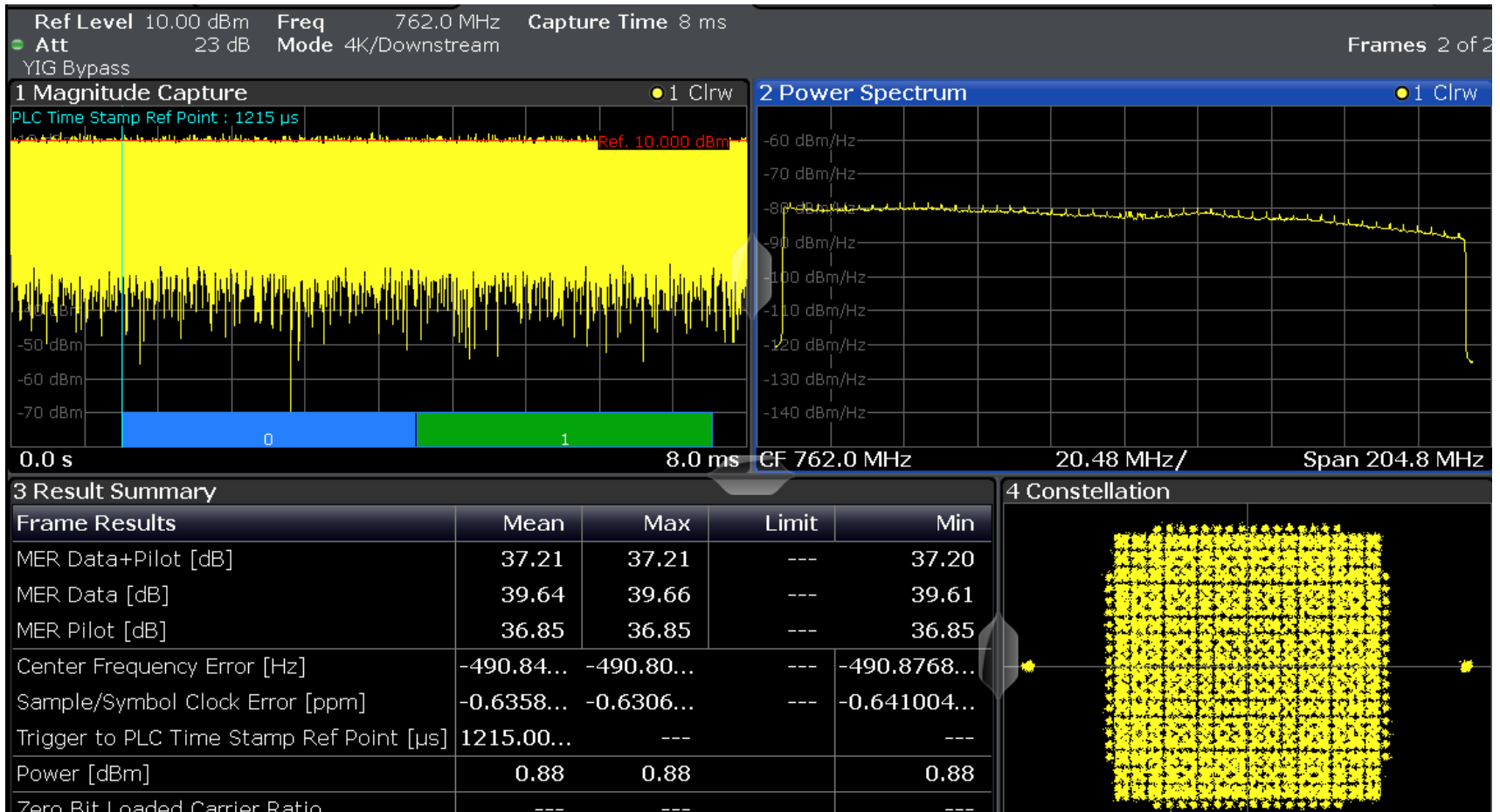

1024QAM at the End of the Cascade

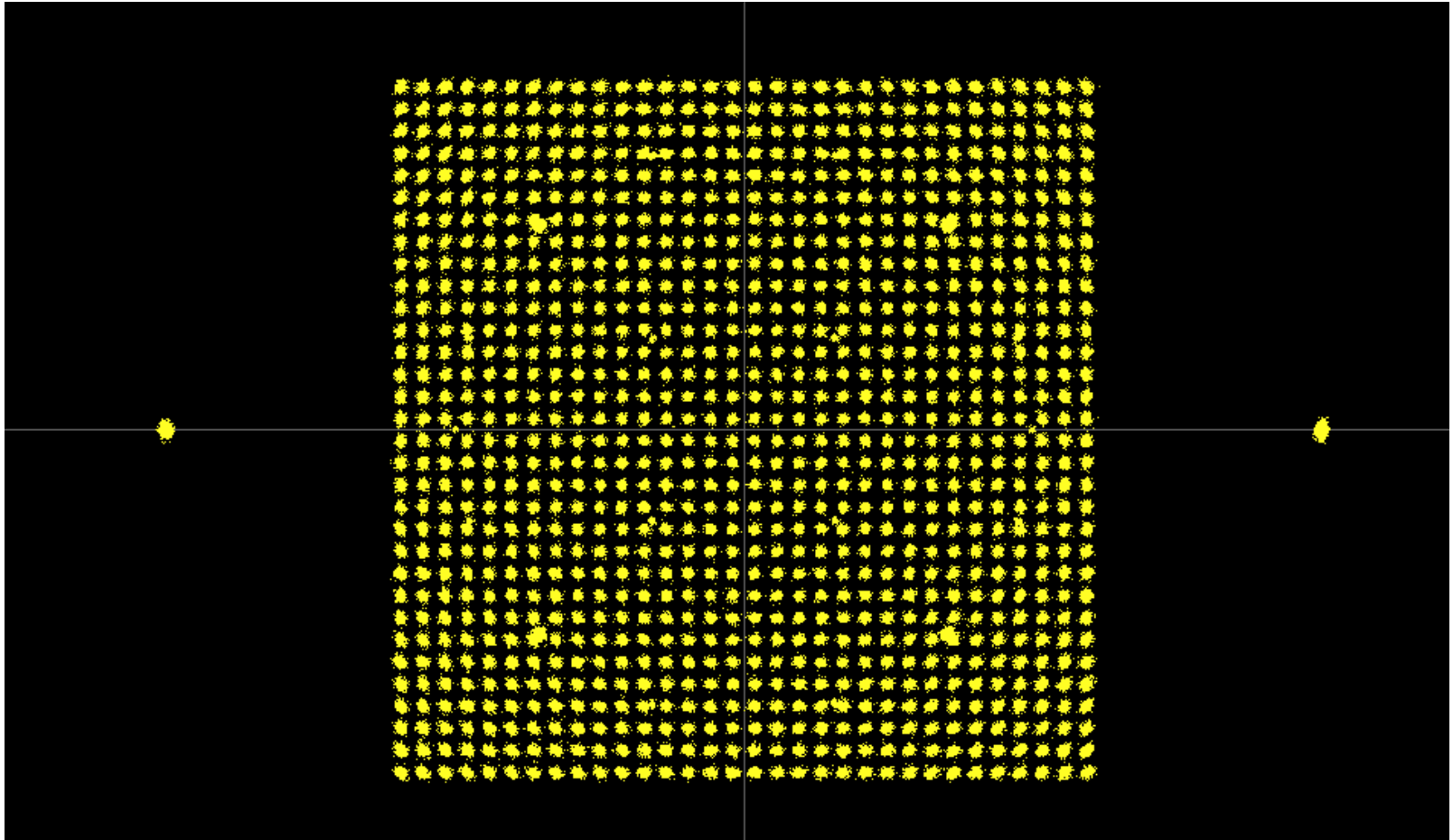

4096QAM at the End of the Cascade

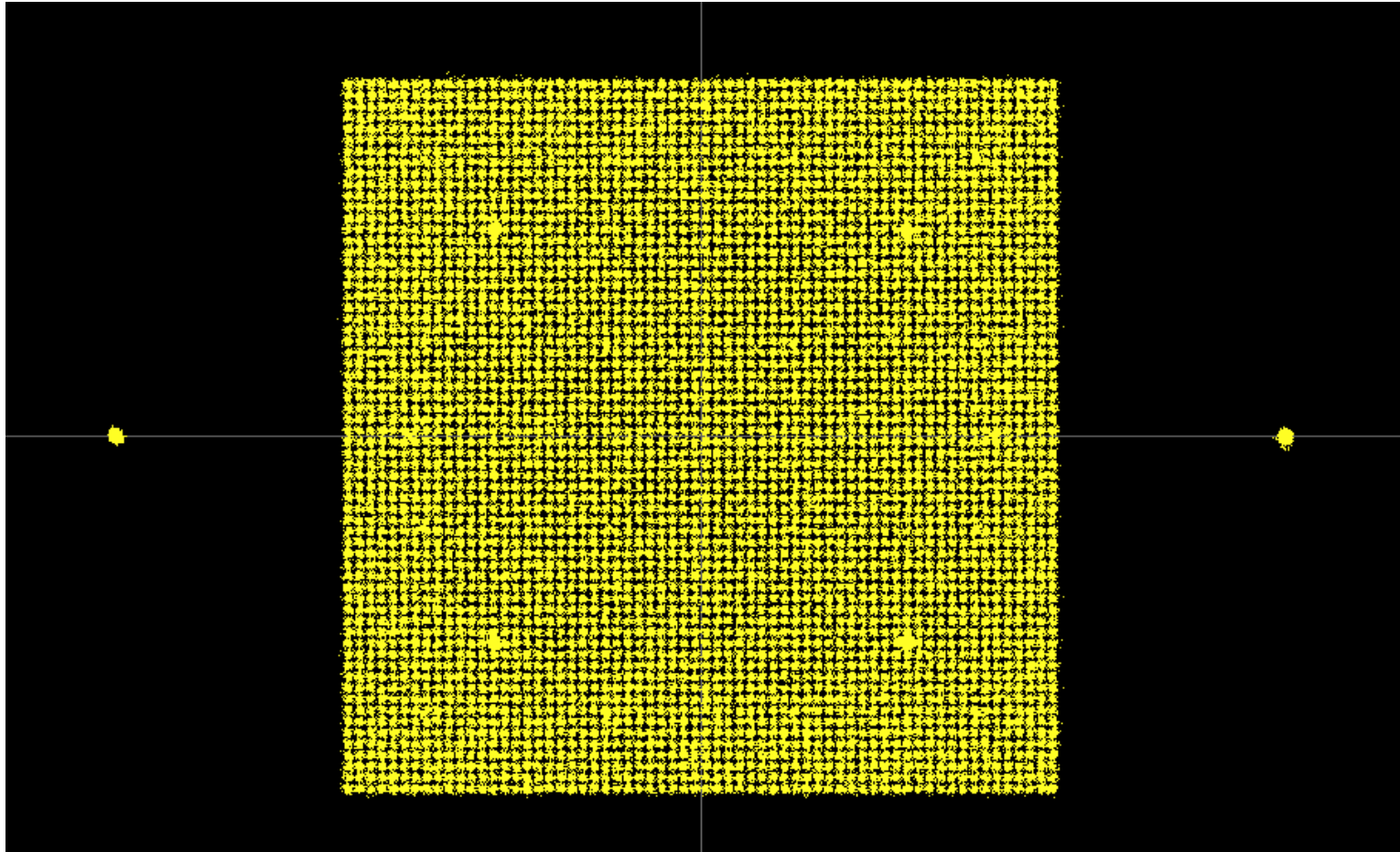

16384QAM (16kQAM) at the End of the Cascade

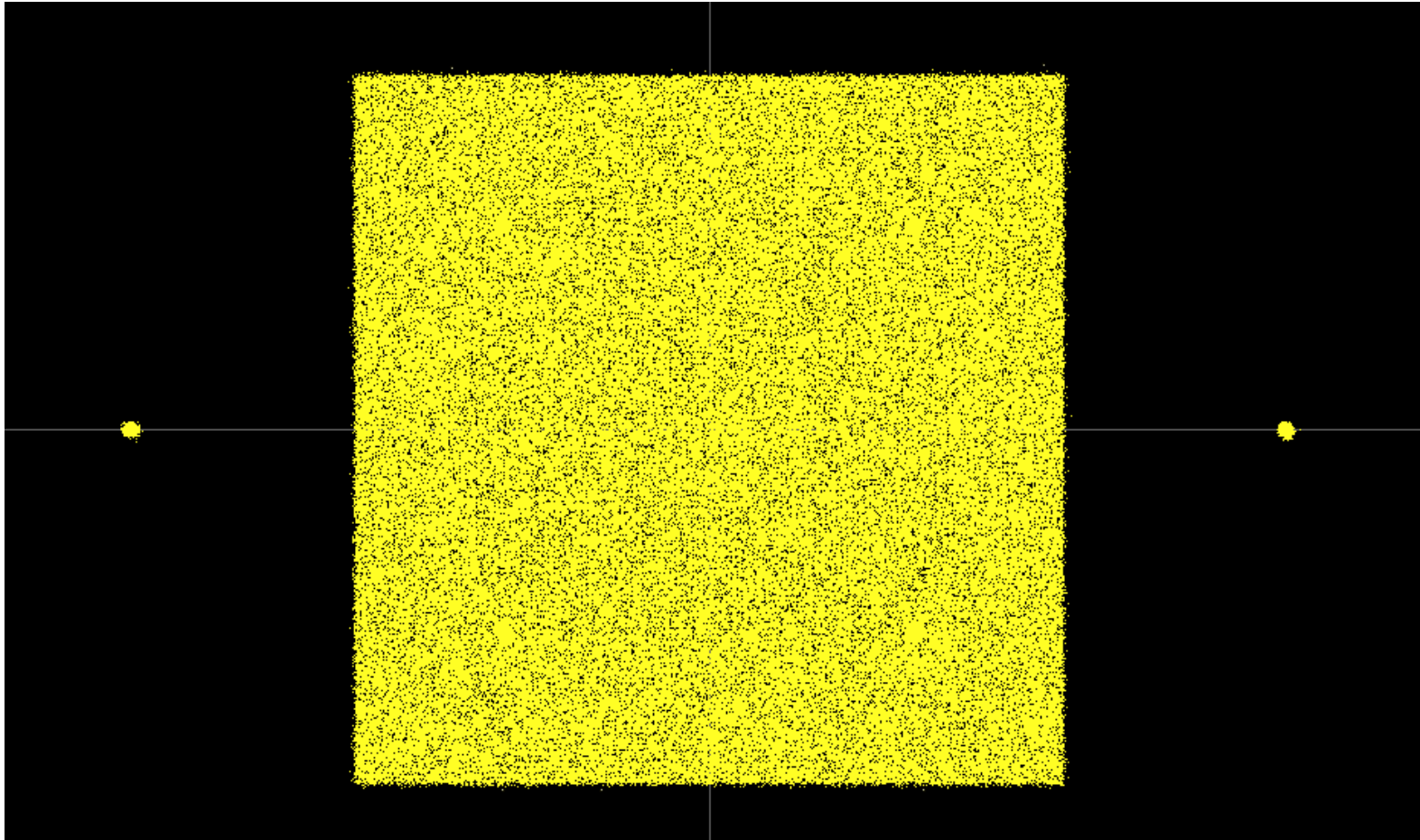



10.11.2017

Vielen Dank!

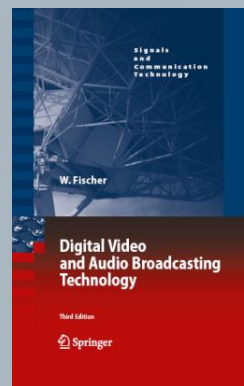
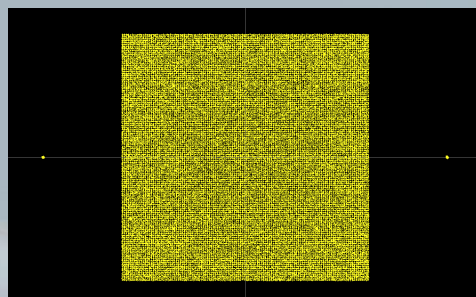

Walter Fischer
Rohde&Schwarz
Training Center Munich
Email: Walter.Fischer@Rohde-Schwarz.com